

# LA TRAX™



## DESERT PRERUNNER

OWNER'S MANUAL

MODEL 76064-5

### CONTENTS

- 2 BEFORE YOU PROCEED
- 3 SAFETY PRECAUTIONS
- 5 SUPPLIED EQUIPMENT
- 6 MODEL OVERVIEW
- 7 GETTING STARTED
- 9 THE 2.4GHz RADIO SYSTEM
- 14 ADJUSTING THE ELECTRONIC SPEED CONTROL
- 16 DRIVING YOUR MODEL
- 18 MAINTAINING YOUR MODEL

Thank you for purchasing a LaTrax 1/18-scale model. Your LaTrax model is a 4WD Desert Prerunner race truck that puts you in the driver's seat for intense fender-to-fender, high flying action. Experience high-speed head-to-head competition at the track or in your own backyard with big-air jumps and full-throttle turns! Superior performance capability, optimum handling, and high speed potential... no detail was spared to bring you an exciting on- or off-track driving adventure!

This manual contains the instructions you will need to operate and maintain your model so that you can enjoy it for years to come. We want you to feel confident that you own one of the best-performing models in the market and that it is backed by a team of professionals who aim to provide the highest level of factory support possible.

This manual contains all the necessary setup and operating procedures that allow you to unlock the performance and potential that our engineers designed into your model. **Even if you are an experienced R/C enthusiast, it's important to read and follow the procedures in this manual.**

Thank you for choosing LaTrax. We hope you enjoy your new model!

### REGISTERING YOUR MODEL

**In order to serve you better as our customer, please register your product within 10 days of your purchase online at [LaTrax.com/register](http://LaTrax.com/register)**



### BEFORE YOU PROCEED

Carefully read and follow all instructions in this and any accompanying materials to prevent serious damage to your model. Failure to follow these instructions will be considered abuse and/or neglect.

Before running your model, look over this entire manual and examine the model carefully. If for some reason you decide it is not what you wanted, then do not continue any further. **Your hobby dealer absolutely cannot accept a model for return or exchange after it has been run.**

### WARNINGS, HELPFUL HINTS, & CROSS-REFERENCES

Throughout this manual, you'll notice warnings and helpful hints identified by the icons below. Be sure to read them!



An important warning about personal safety or avoiding damage to your model and related components.



Special advice to make things easier and more fun.



Refers you to a page with a related topic.

### CUSTOMER SUPPORT

Our Customer Support team is with you every step of the way. If you have any questions about your model or its operation, call the LaTrax Technical Support Line toll-free at: 1-888-872-9927\*.

\*Toll-free support is available to U.S. residents only.

Technical support is available Monday through Friday from 8:30am to 9:00pm central time. Technical assistance is also available at LaTrax.com. You may also e-mail customer support with your question at support@LaTrax.com. Join thousands of registered members in our online community at LaTrax.com.

LaTrax offers a full-service, on-site repair facility to handle any of your service needs. Maintenance and replacement parts may be purchased directly from LaTrax by phone or online at LaTrax.com. You can save time, along with shipping and handling costs, by purchasing replacement parts from your local dealer.

Do not hesitate to contact us with any of your product support needs. We want you to be thoroughly satisfied with your new model!

## SAFETY PRECAUTIONS

We want you to safely enjoy your new model. Operate your model sensibly and with care, and it will be exciting, safe, and fun for you and those around you. Failure to operate your model in a safe and responsible manner may result in property damage and serious injury. The precautions outlined in this manual should be strictly followed to help ensure safe operation. You alone must see that the instructions are followed and the precautions are adhered to.

 **All instructions and precautions outlined in this manual should be strictly followed to ensure safe operation of your model. This model is not intended for use by children under 14 years of age without the supervision of a responsible and knowledgeable adult.**

### Important Points to Remember

- Your model is not intended for use on public roads or congested areas where its operation can conflict with or disrupt pedestrian or vehicular traffic.
- Never, under any circumstances, operate the model in crowds of people. Your model is fast and could cause injury if allowed to collide with anyone.
- Because your model is controlled by radio, it is subject to radio interference from many sources that are beyond your control. Since radio interference can cause momentary losses of radio control, always allow a safety

margin in all directions around the model in order to prevent collisions.

- The motor and battery can become hot during use. Be careful to avoid getting burned.
- Don't operate your model at night, or anytime your line of sight to the model may be obstructed or impaired in any way.
- **Most importantly, use good common sense at all times.**

### Speed Control

- **Disconnect the Battery:** Always disconnect the battery from the model when not in use.
- **Transmitter on First:** Switch on your transmitter first before switching on the speed control to prevent runaways and erratic performance.
- **Don't Get Burned:** The motor can become extremely hot during use, so be careful not to touch it until it is cool. Make sure there is adequate airflow to the motor.
- **Use the Factory-Installed Connectors:** Do not change the battery connector. Improper wiring can cause fire or damage to the ESC. Please note that modified speed controls can be subject to a rewiring fee when returned for service.
- **Insulate the Wires:** Always insulate exposed or damaged wiring with heat shrink tubing to prevent short circuits.
- **No Reverse Voltage:** The speed control is not protected against reverse polarity voltage. When changing the battery, be sure to install the same type of connectors to avoid reverse polarity damage to the speed control. Removing the battery connectors on the speed control or using the same-gender connectors on the speed control will void the product's warranty.
- **No Schottky Diodes:** External Schottky diodes are not compatible with reversing speed controls. Using a Schottky diode will damage the ESC and void the 30-day warranty.

### Recycling Your NiMH Battery

It is strongly recommended that you recycle the vehicle battery when it has reached the end of its useful life. **Do not throw your battery in the trash.** To find a recycling center near you, ask your local hobby dealer or visit [www.call2recycle.org](http://www.call2recycle.org).

#### FCC Compliance

This device contains a module that complies with the limits for a Class B digital device as described in part 15 of the FCC rules. Operation is subject to the following two conditions: (1) This device may not cause harmful interference, and (2) this device must accept any interference received, including interference that may cause undesired operation.

The limits for a Class B digital device are designed to provide reasonable protection against harmful interference in residential settings. This product generates, uses, and can radiate radio frequency energy, and, if not operated in accordance with the instructions, may cause harmful interference to radio communications. The user is cautioned that changes or modifications not expressly approved by the party responsible for compliance could void the user's authority to operate the equipment.

#### Canada, Industry Canada (IC)

This Class B digital apparatus complies with Canadian ICES-003 and RSS-210. This device complies with Industry Canada license exempt RSS standard(s). Operation is subject to the following two conditions: This device may not cause interference, and this device must accept any interference, including interference that may cause undesired operation of the device.

#### Radio Frequency (RF) Exposure Statement

This equipment complies with radio frequency exposure limits set forth by FCC and Industry Canada for an uncontrolled environment. This equipment should be installed and operated with a minimum distance of 20 centimeters between the radiator and your body or bystanders and must not be co-located or operating in conjunction with any other antenna or transmitter.



**FIRE HAZARD!** Your model is able to use LiPo batteries. Charging and discharging batteries has the potential for fire, explosion, serious injury, and property damage if not performed per the instructions. Before use, read and follow all manufacturer's instructions, warnings, and precautions. In addition, Lithium Polymer (LiPo) batteries pose a SEVERE risk of fire if not properly handled per the instructions and require special care and handling procedures for long life and safe operation. LiPo batteries are intended only for advanced users that are educated on the risks associated with LiPo battery use. Traxxas does not recommend that anyone under the age of 14 use or handle LiPo battery packs without the supervision of a knowledgeable and responsible adult. Dispose of used batteries according to the instructions.

**Important Warnings for users of Lithium Polymer (LiPo) batteries:**

- LiPo batteries have a minimum safe discharge voltage threshold that should not be exceeded. The electronic speed control is equipped with built-in Low-Voltage Detection that alerts the driver when LiPo batteries have reached their minimum voltage (discharge) threshold. It is the driver's responsibility to stop immediately to prevent the battery pack from being discharged below its safe minimum threshold.
- Low-Voltage Detection is just one part of a comprehensive plan for safe LiPo battery use. It is critical to follow all instructions for safe and proper charging, use, and storage of LiPo batteries. Make sure you understand how to use your LiPo batteries. If you have questions about LiPo battery usage, please consult with your local hobby dealer or contact the battery manufacturer. As a reminder, all batteries should be recycled at the end of their useful life.
- ONLY use a Lithium Polymer (LiPo) balance charger with a balance adapter port to charge LiPo batteries. Never use NiMH or NiCad-type chargers or charge modes to charge LiPo batteries. DO NOT charge with a NiMH-only charger. The use of a NiMH or NiCad charger or charge mode will damage the batteries and may cause fire and personal injury.
- NEVER charge LiPo battery packs in series or parallel. Charging packs in series or parallel may result in improper charger cell recognition and an improper charging rate that may lead to overcharging, cell imbalance, cell damage, and fire.

**WARNING! CAUTION! DANGER!**



- ALWAYS inspect your LiPo batteries carefully before charging. Look for any loose leads or connectors, damaged wire insulation, damaged cell packaging, impact damage, fluid leaks, swelling (a sign of internal damage), cell deformity, missing labels, or any other damage or irregularity. If any of these conditions are observed, do not charge or use the battery pack. Follow the disposal instructions included with your battery to properly and safely dispose of the battery.
- DO NOT store or charge LiPo batteries with or around other batteries or battery packs of any type, including other LiPos.
- Store and transport your battery pack(s) in a cool dry place. DO NOT store in direct sunlight. DO NOT allow the storage temperature to exceed 140°F or 60°C, such as in the trunk of a car, or the cells may be damaged and create a fire risk.
- DO NOT disassemble LiPo batteries or cells.
- DO NOT attempt to build your own LiPo battery pack from loose cells.

**Charging and handling precautions for all battery types:**

- Use the supplied NiMH charger to charge the included battery. DO NOT attempt to charge LiPo batteries or any other type of battery with this charger.
- BEFORE you charge, ALWAYS confirm that the charger settings exactly match the type (chemistry), specification, and configuration of the battery to be charged.
- DO NOT attempt to charge non-rechargeable batteries (explosion hazard), batteries that have an internal charge circuit or a protection circuit, batteries that have been altered from original manufacturer configuration, or batteries that have missing or unreadable labels, preventing you from properly identifying the battery type and specifications.
- DO NOT exceed the maximum manufacturer recommended charge rate.
- DO NOT let any exposed battery contacts or wires touch each other. This will cause the battery to short circuit and create the risk of fire.
- While charging or discharging, ALWAYS place the battery (all types of batteries) in a fire retardant/fire proof container and on a non-flammable surface such as concrete.

(continued on next page)

(continued from previous page)

- DO NOT charge batteries inside of an automobile. DO NOT charge batteries while driving in an automobile. This charger is equipped with a long cord intended to allow the battery to be charged outside of an automobile when using the automobile's auxiliary power socket. If the cord will not reach outside of the automobile, find another power source.
- NEVER charge batteries on wood, cloth, carpet, or on any other flammable material.
- ALWAYS charge batteries in a well-ventilated area.
- REMOVE flammable items and combustible materials from the charging area.
- DO NOT leave the charger and battery unattended while charging, discharging, or anytime the charger is ON with a battery connected. If there are any signs of a malfunction or in the event of an emergency, unplug the charger from the power source and disconnect the battery from the charger.
- DO NOT operate the charger in a cluttered space, or place objects on top of the charger or battery.
- If any battery or battery cell is damaged in any way, DO NOT charge, discharge, or use the battery.
- Keep a Class D fire extinguisher nearby in case of fire.
- DO NOT disassemble, crush, short circuit, or expose the batteries to flame or other source of ignition. Toxic materials could be released. If eye or skin contact occurs, flush with water.
- If a battery gets hot to the touch during the charging process (temperature greater than 110°F / 43°C), immediately disconnect the battery from the charger and discontinue charging.
- Allow the battery pack to cool off between runs (before charging).
- ALWAYS unplug the charger and disconnect the battery when not in use.
- ALWAYS unplug the battery from the electronic speed control when the model is not in use and when it is being stored or transported.
- DO NOT disassemble the charger.
- REMOVE the battery from your model or device before charging.
- DO NOT expose the charger to water or moisture.
- ALWAYS store battery packs safely out of the reach of children or pets. Children should always have adult supervision when charging and handling batteries.
- Nickel-Metal Hydride (NiMH) batteries must be recycled or disposed of properly.
- Always proceed with caution and use good common sense at all times.

## SUPPLIED EQUIPMENT

Your model comes equipped with certain items to help you get it up and running. You will need to purchase other items, available from your hobby dealer, to operate and maintain your model.

### Supplied Equipment



NiMH battery charger\*



6-cell 2/3A NiMH battery\*



4 AA alkaline batteries

**i Recommended Equipment** (sold separately)  
 These items are not required for the operation of your model, but are a good idea to include in any R/C toolbox:

- Safety glasses
- Traxxas Ultra Premium Tire Glue, Part #6468 (CA glue)
- Hobby knife
- Side cutters and needle nose pliers
- Phillips screwdriver
- Complete hex key set
- Soldering iron

\*Battery and charger style are subject to change and may vary from images.

## MODEL OVERVIEW

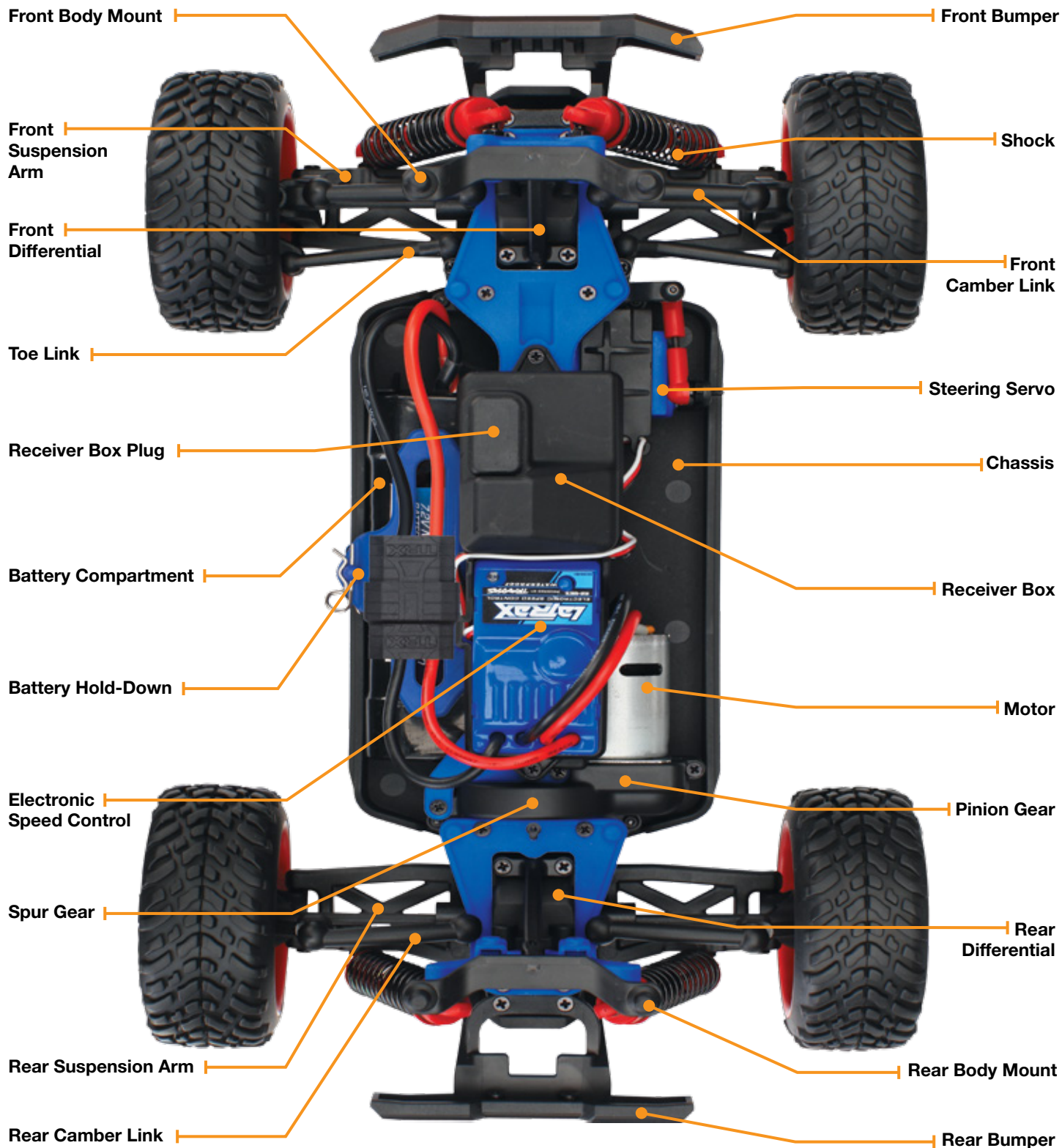

## GETTING STARTED

### INSTALLING TRANSMITTER BATTERIES

Your transmitter uses 4 AA batteries. The battery compartment is located in the base of the transmitter.

1. Remove the battery compartment door by pressing the tab and sliding the door open.
2. Install the batteries in the correct orientation, as indicated in the battery compartment.
3. Reinstall the battery compartment door and snap it closed.
4. Turn on the transmitter and check the status LED for a solid green light.



If the status LED flashes red, the transmitter batteries may be weak, discharged, or possibly installed incorrectly. Replace with new or freshly charged batteries. The status LED does not indicate the charge level of the battery pack installed in the model. Refer to the Troubleshooting section on page 13 for more information on the transmitter status LED codes.



*If the status LED doesn't light green on the transmitter, check the polarity of the batteries. Check rechargeable batteries for a full charge. If you see any other flashing signal from the LED, refer to the chart on page 13 to identify the code.*



#### Use the Right Batteries

Your transmitter uses AA batteries. New Traxxas alkaline batteries (part #2914) are included with your model. You may also use rechargeable batteries, such as NiMH (nickel-metal hydride) batteries, in your transmitter. Make sure rechargeable batteries are fully charged according to the manufacturer's instructions.

If you use rechargeable batteries in your transmitter, be aware that when they begin to lose their charge, they lose power more quickly than regular alkaline batteries.

**CAUTION:** Discontinue running your model at the first sign of weak batteries (flashing red light) to avoid losing control.



## WARNING: FIRE HAZARD!

**DO NOT ATTEMPT TO CHARGE LIPO BATTERIES WITH THE TRAXXAS NiMH CHARGER INCLUDED IN THIS PACKAGE.**

*The included NiMH charger can only be used with Traxxas NiMH batteries equipped with the iD High-Current Connector as shown.*

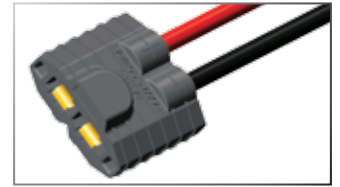

*Please examine your connector to make sure that it is the proper connector. All batteries equipped with legacy Traxxas High-Current Connectors are not compatible with the included NiMH charger. DO NOT try to force legacy Traxxas High-Current Connectors, or any other type of connector, into the charger connector. DO NOT attempt to charge any batteries with the included NiMH charger if you are unsure of the battery type, the connector type, or if the original connector on the battery has been changed.*

*If you do not understand this warning, please contact Traxxas Customer Support at 1-888-TRAXXAS (1-888-872-9927)\* or your local hobby dealer for more information.*

### CHARGING THE BATTERY PACK

Plug the charger into a wall outlet. The LED on the charger will glow green. Plug the battery into the charger. The LED will glow red, indicating the battery is charging. Charge time is approximately 3 ½ hours. The LED will turn green when the battery is fully charged.

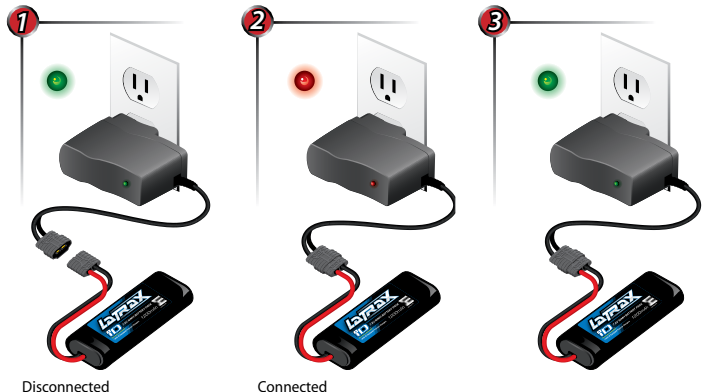

\*Toll-free support is available to U.S. residents only; outside the U.S., please call +1972-549-3000.

### INSTALLING THE BATTERY PACK

Your model includes a 7.2V 6-cell NiMH battery pack. Follow these steps to install the battery:

1. Remove the body clip from the battery hold-down, and then remove the battery hold-down.
2. Install the battery pack into the battery compartment with the battery wires facing the front of the model.
3. Reinstall the battery hold-down, making sure not to pinch the battery wires. Secure the battery hold-down with the body clip. **Do not connect the battery pack to the ESC at this time.**

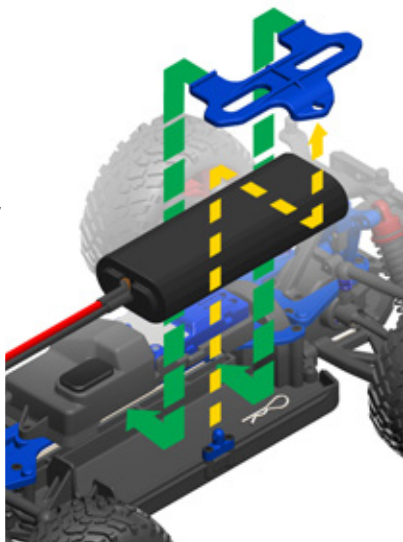

**Note:** Always unplug the battery and remove from the model after use.



### THE 2.4GHz RADIO SYSTEM

Your model includes a 2.4GHz transmitter. When powered on, the transmitter will automatically locate and lock onto an available frequency, allowing multiple models to be raced together without frequency conflicts. The included radio system has been programmed for your model at the factory and does not require adjustment, but it does have settings you may need to access to maintain proper operation of your model. The detailed instructions (page 11) included in this manual will help you understand and operate the functions of the radio system. For additional information and how-to videos, visit [LaTrax.com](http://LaTrax.com).

### RADIO AND POWER SYSTEM TERMINOLOGY

Please take a moment to familiarize yourself with these radio and power system terms. They will be used throughout this manual.

**2.4GHz Spread Spectrum** – This model is equipped with the latest R/C technology. Unlike AM and FM systems that require frequency crystals and are prone to frequency conflicts, the 2.4GHz radio system automatically selects and locks onto an open frequency, offering superior resistance to interference and “glitching.”

**BEC (Battery Eliminator Circuit)** - The BEC can either be in the receiver or in the ESC. This circuit allows the receiver and servos to be powered by the main battery pack in an electric model. This eliminates the need to carry a separate pack of 4 AA batteries to power the radio equipment.

**Current** - Current is a measure of power flow through the electronics, usually measured in amps. If you look at wire like a garden hose, current is a measure of how much water is flowing through the hose.

**Electronic Speed Control (ESC)** - An electronic speed control is the electronic motor control inside the model. ESCs use power more efficiently than mechanical speed controls so that the battery runs longer. An ESC also has circuitry that prevents loss of steering and throttle control as the battery loses its charge.

**Frequency band** - The radio frequency used by the transmitter to send signals to your model. This model operates on the 2.4GHz direct-sequence spread spectrum.

**mAh** – Abbreviation for milliamp hour, a measure of the capacity of the battery pack. The higher the number, the longer the battery will last between recharges.

**Neutral position** - The standing position that the servos seek when the transmitter controls are at the neutral setting.

**NiMH** - Abbreviation for nickel-metal hydride. Rechargeable NiMH batteries offer high current handling and much greater resistance to the “memory” effect. NiMH batteries generally allow higher capacity than NiCad batteries. They can last up to 500 charge cycles. A peak charger designed for NiMH batteries is required for optimal performance.

**Receiver** - The radio unit inside your model that receives signals from the transmitter and relays them to the servos.

**Resistance** - In an electrical sense, resistance is a measure of how an object resists or obstructs the flow of current through it. When flow is constricted, energy is converted to heat and is lost. The power system is optimized to reduce electrical resistance and the resulting power-robbing heat.

**Servo** - Small motor unit in your model that operates the steering mechanism.

**Transmitter** - The hand-held radio unit that sends throttle and steering instructions to your model.

**Trim** - The fine-tuning adjustment of the neutral position of the servos, made by adjusting the steering trim knob on the face of the transmitter.

**Thermal Shutdown Protection** - Temperature sensing electronics used in the ESC detect overloading and overheating of the transistor circuitry. If excessive temperature is detected, the unit automatically shuts down to prevent damage to the electronics.

**2-channel radio system** - The 2.4GHz radio system, consisting of the receiver, the transmitter, and the servos. The system uses two channels: one to operate the throttle and one to operate the steering.

**Voltage** - Voltage is a measure of the electrical potential difference between two points, such as between the positive battery terminal and ground. Using the analogy of the garden hose, while current is the quantity of water flow in the hose, voltage corresponds to the pressure that is forcing the water through the hose.

# THE 2.4GHz RADIO SYSTEM

## RADIO SYSTEM RULES

- The 2.4GHz transmitter has a directional antenna. For maximum range, hold the transmitter upright and pointed in the direction of the model. Pointing the transmitter away from the model will reduce radio range.

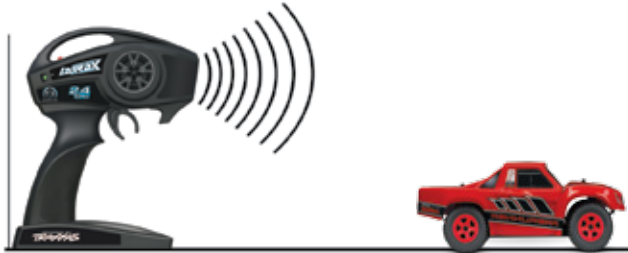

- Always turn your transmitter on first and off last. This procedure will help to prevent your model from receiving stray signals from another transmitter, or other source, and running out of control. Your model has electronic failsafes to prevent this type of malfunction, but the first, best defense against a runaway model is to **always turn the transmitter on first and off last.**

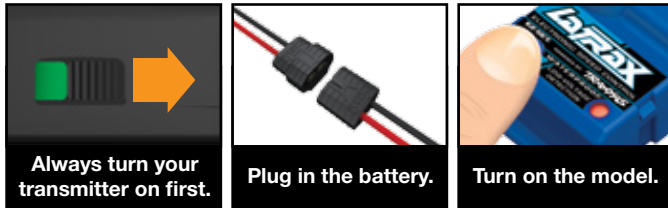

- Always use new or freshly charged batteries for the radio system. Weak batteries will limit the radio signal between the receiver and the transmitter. Loss of the radio signal can cause you to lose control of your model.
- In order for the transmitter and receiver to bind to one another, the receiver in the model must be turned on within 20 seconds of turning on the transmitter. The transmitter LED will flash fast red, indicating a failure to link. If you miss it, simply turn off the transmitter and start over.
- DO NOT CUT any part of the receiver's antenna wire. Cutting the antenna will reduce range.

**!** *When rechargeable batteries begin to lose their charge, they will fade much faster than alkaline dry cells. Stop immediately at the first sign of weak batteries. Never turn the transmitter off when the battery pack is plugged in. The model could run out of control.*

## TRANSMITTER



## RADIO SYSTEM WIRING DIAGRAM

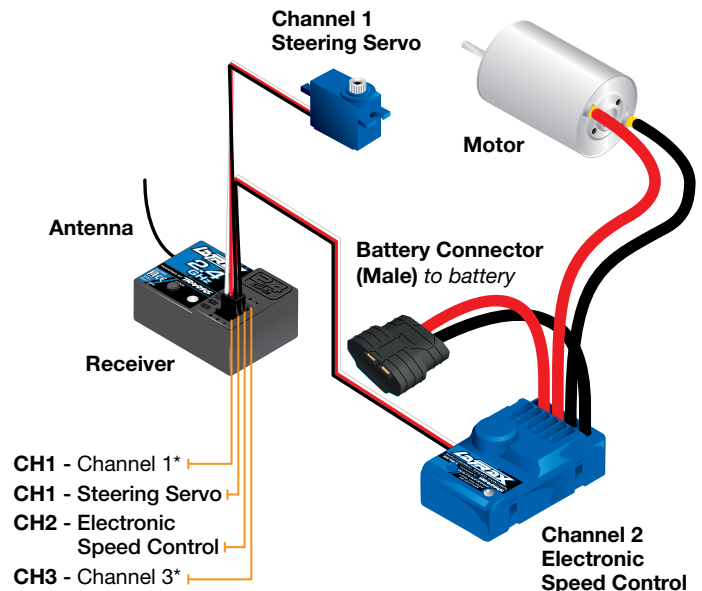

\*Not used

## RADIO SYSTEM CONTROLS



**i** **Using Reverse:** While driving, push the throttle trigger forward to apply brakes. Once stopped, return the throttle trigger to neutral. Push the throttle trigger forward again to engage proportional reverse.

## USING THE RADIO SYSTEM

The 2.4GHz Radio System has been adjusted at the factory for correct operation with your model. The adjustment should be checked before running the model, in case of movement during shipping. Here's how:

1. Turn the transmitter switch on. The status LED on the transmitter should be solid green (not flashing).
2. Elevate the model on a block or a stand so that all the tires are off the ground. Make sure your hands are clear of the moving parts of the model.
3. Plug the battery pack connector into the speed control connector.
4. The on/off switch is integrated into the speed control. Press and release the EZ-Set button to turn the model on. The LED will shine RED (see note, below). To turn the ESC off, press and hold the EZ-Set button until the LED turns off. **Note:** *If the LED shines green, Low-Voltage Detection is activated. This may cause poor performance from the included NiMH battery pack. The default factory setting is for Low-Voltage Detection to be disabled (LED shines red). See page 15 for more information on Low-Voltage Detection.*
5. Turn the steering wheel on the transmitter back and forth and check for rapid operation of the steering

servo. Also, check that the steering mechanism is not loose or binding. If the steering operates slowly, check for weak batteries.

6. When looking down at the model, the front wheels should be pointing straight ahead. If the wheels are turned slightly to the left or right, slowly adjust the steering trim control on the transmitter until they are pointing straight ahead.
7. Gently operate the throttle trigger to ensure that you have forward and reverse operation, and that the motor stops when the throttle trigger is at neutral.
8. Once adjustments are made, turn off the receiver on your model, followed by the hand-held transmitter.

## Range-Testing the Radio System

Before each running session with your model, you should range-test your radio system to ensure that it operates properly.

1. Turn on the radio system and check its operation, as described in the previous section.
2. Have a friend hold the model. Make sure hands and clothing are clear of the wheels and other moving parts on the model.
3. Walk away from the model with the transmitter until you reach the farthest distance you plan to operate the model.
4. Operate the controls on the transmitter once again to be sure that the model responds correctly.
5. Do not attempt to operate the model if there is any problem with the radio system or any external interference with your radio signal at your location.

## Higher Speeds Require Greater Distance

The faster you drive your model, the more quickly it will near the limit of radio range. At top speed, this model can cover up to 40 feet per second! It's a thrill, but use caution to keep your model in range. If you want to see your model achieve its maximum speed, it is best to position yourself in the middle of the model's running area, not the far end, so you drive the model toward and past your position. In addition to maximizing the radio's range, this technique will keep your model closer to you, making it easier to see and control.

**!** *No matter how fast or far you drive your model, always leave adequate space between you, the model, and others. Never drive directly toward yourself or others.*

## RADIO SYSTEM BASIC ADJUSTMENTS



### Steering Trim

The steering trim knob located on the face of the transmitter adjusts the neutral (center) point of the steering channel. If your model pulls to the right or left when the steering wheel is centered, turn the knob until the model drives straight when the steering wheel is centered.

### Channel Reversing

The 2.4GHz transmitter has been programmed with the correct servo direction settings for your model and should not require adjustment. These instructions are for reference and troubleshooting only.

Reversing a channel reverses the direction of the corresponding servo. For example, if you turn the steering wheel to the right and the model turns left, Channel 1 would need to be reversed to correct the servo direction. Use the following procedures to reverse the steering and throttle channels, if necessary. Servo reversing should only be required if you accidentally reset the direction of a channel. **Do not reverse the steering or throttle channels unless necessary.**

#### Steering reversing procedure:

1. Press and hold the SET button on the transmitter for two seconds. The status LED will flash green.
2. Turn and hold the steering wheel to the full left or full right position (it does not matter which position you choose).
3. While holding the steering wheel in position, press the SET button to reverse the channel.
4. The channel is now reversed. Confirm correct servo operation before running your model.

#### Throttle reversing procedure:

**Note:** *Throttle reversing is often times unnecessary on electric models, as issues with the throttle can usually be solved by reprogramming the speed control and/or verifying that the motor is wired correctly. Before attempting to reverse the throttle channel using the procedure below, you should first recalibrate the speed control. Refer to “ESC Setup Programming” on page 15.*

1. Press and hold the SET button on the transmitter for two seconds. The status LED will flash green.
2. Move and hold the throttle trigger to the full forward or full brake position (it does not matter which position you choose).

3. While holding the throttle trigger in position, press the SET button to reverse the channel.
4. The channel is now reversed. Recalibrate the speed control and then confirm correct servo operation before running your model.

### Binding Instructions

For proper operation, the transmitter and receiver must be electronically “bound”. This has been done for you at the factory. Should you ever need to re-bind the system or bind to an additional transmitter or receiver, follow these instructions. **Note:** *The receiver must be connected to a 4.8-6.0v (nominal) power source for binding and the transmitter and receiver must be within 5 feet of each other.*

1. Press and hold the SET button on the transmitter.
2. Turn on the transmitter and release the SET button. The status LED will flash red slowly, indicating that the transmitter is in bind mode.
3. Press and hold the LINK button on the receiver.
4. Turn on the speed control by pressing the EZ-Set button, and release the LINK button.
5. When the LEDs on both the transmitter and the receiver turn solid green, the system is bound and ready for use. Confirm that the steering and throttle operate properly before driving your model.



### Failsafe

*The 2.4GHz radio system is equipped with a built-in failsafe function that returns the throttle to its last saved neutral position in the event of a signal loss. The LED on the transmitter and the receiver will rapidly flash red when the failsafe mode is activated. If failsafe activates while you are operating your model, determine the reason for signal loss and resolve the problem before operating your model again.*

**TRANSMITTER LED CODES**

LED Color / Pattern	Name	Notes
Solid green	Normal Driving Mode	See page 11 for information on how to use the transmitter controls.
Slow red (0.5 sec on / 0.5 sec off)	Binding	See page 12 for more information on binding.
Flashing medium red (0.25 sec on / 0.25 sec off)	Low Battery Alarm	Put new batteries in the transmitter. See page 7 for more information.
Flashing fast red (0.125 sec on / 0.125 sec off)	Link Failure / Error	Transmitter and receiver are no longer bound. Turn the system off and then back on to resume normal operation. Find source of the link failure (i.e., out of range, low batteries, damaged antenna).

**RECEIVER LED CODES**

LED Color / Pattern	Name	Notes
Solid green	Normal Driving Mode	See page 11 for information on how to use your transmitter controls.
Slow red (0.5 sec on / 0.5 sec off)	Binding	See page 12 for more information on binding.
Flashing fast red (0.125 sec on / 0.125 sec off)	Failsafe / Low-Voltage Detect	Consistent low voltage in the receiver triggers failsafe so that there is enough power to center the throttle servo before it completely loses power.

## PROFILE SELECTION

The speed control is factory set to Sport Mode (100% forward, brakes, and reverse). You can program the speed control to disable reverse (Race Mode) or to allow 50% power (patent-pending Training Mode) using the following mode selection procedures. Please note that the speed control should be connected to the receiver and the transmitter adjusted as described previously. The profiles are selected by entering the programming mode.

### Selecting Sport Mode

(Profile #1: 100% Forward, 100% Brakes, 100% Reverse)

1. Connect a fully charged battery pack to the model and turn on your transmitter.
2. With the ESC off, press and hold the EZ-Set button until the LED turns solid green, then solid red, and then begins blinking red (indicating the Profile numbers).
3. When the LED blinks RED ONCE, release the EZ-Set button.
4. The LED will blink and then turn solid red. The model is ready to drive.



### Selecting Race Mode

(Profile #2: 100% Forward, 100% Brakes, No Reverse)

1. Connect a fully charged battery pack to the model and turn on your transmitter.
2. With the ESC off, press and hold the EZ-Set button until the LED turns solid green, then solid red, and then begins blinking red (indicating the Profile numbers).
3. When the LED blinks RED TWICE, release the EZ-Set button.
4. The LED will blink and then turn solid red. The model is ready to drive.



### Selecting Training Mode

(Profile #3: 50% Forward, 100% Brakes, 50% Reverse)

1. Connect a fully charged battery pack to the model and turn on your transmitter.

2. With the ESC off, press and hold the EZ-Set button until the LED turns solid green, then solid red, and then begins blinking red (indicating the Profile numbers).
3. When the LED blinks RED THREE TIMES, release the EZ-Set button.
4. The LED will blink and then turn solid red. The model is ready to drive.



**i** Patent-Pending Training Mode (Profile #3) reduces forward and reverse throttle by 50%. Training Mode is provided to reduce the power output, allowing beginning drivers to better control the model. As driving skills improve, simply change to Sport or Race Mode for full-power operation.

**i** If you missed the mode you wanted, keep the EZ-Set button pressed down and the blink cycle will repeat until the button is released and a Mode is selected.

**i** **Tip For Fast Mode Changes**  
The ESC is set to Profile 1 (Sport Mode) as the default. To quickly change to Profile 3 (Training Mode), with the transmitter on and the ESC turned off, press and hold the SET button until the light blinks red three times and then release. For full power, turn off the ESC then quickly change back to Profile 1 (Sport Mode) by pressing and holding the SET button until the light blinks red one time and then releasing.

## ESC OPERATION

To operate the speed control and test the programming, place the vehicle on a stable block or stand so that all of the wheels are off the ground.

1. With the transmitter on, press and release the EZ-Set button. The LED will shine RED. This turns the ESC on. If you press and release too quickly, you may hear the steering servo jump but the LED may not stay on. Simply press the button again until the LED shines RED and then release.
2. Apply forward throttle. The LED will turn off until full throttle power is reached. At full throttle, the LED will shine RED.
3. Move the trigger forward to apply the brakes. Note that braking control is fully proportional. The LED will turn off until full braking power is reached. At full brakes, the LED will shine RED.
4. Return the throttle trigger to neutral. The LED will shine RED.

5. Move the throttle trigger forward again to engage reverse (Profile #1). The LED will turn off. Once full reverse power is reached, the LED will shine RED.
6. To stop, return the throttle trigger to neutral. Note that there is no programmed delay when changing from reverse to forward. Use caution to avoid slamming the speed control from reverse to forward. On high-traction surfaces, this could result in transmission or driveline damage.
7. To turn the ESC off, press and hold the EZ-Set button until the red LED turns off.
8. The ESC is equipped with thermal shutdown protection to guard against overheating caused by excessive current flow. If the operating temperature exceeds safe limits, the ESC will automatically shut down. The LED on the face of the ESC will rapidly blink red, even if the throttle trigger is moved back and forth. Once the temperature returns to a safe level, the ESC will once again function normally.

## ESC Setup Programming (Calibrating your ESC and transmitter)

Read through all of the programming steps before you begin. If you get lost during programming or receive unexpected results, simply unplug the battery, wait a few seconds, plug the battery back in, and start over.

1. Elevate the model on a block or a stand so that all the tires are off the ground. This is a precaution to prevent runaway when the speed control is turned on before it is programmed.
2. Connect a fully charged battery pack to the ESC.
3. Turn on the transmitter (with the throttle at neutral).
4. Press and hold the EZ-Set button (A). The LED will first turn green and then red. Release the button.
 

Green then Red, Release
5. When the LED blinks RED ONCE, pull the throttle trigger to the full throttle position and hold it there (B).
 

Once Red
6. When the LED blinks RED TWICE, push the throttle trigger to the full reverse and hold it there (C).
 

Twice Red
7. When the LED blinks GREEN ONCE, programming is complete. The LED will then shine red, indicating the ESC is on and at neutral (D).
 

Solid Red

## ESC Battery Settings (Low-Voltage Detection Setting)

The ESC is equipped with a built-in Low-Voltage Detection feature that constantly monitors the battery voltage when activated. **This feature is not compatible with the NiMH battery supplied with your model.** Low-Voltage Detection has been DISABLED for best performance with your battery; however, you should verify that the setting has not been changed before each use.

### Verify that Low-Voltage Detection is DISABLED:

1. Turn on the transmitter (with the throttle at neutral).
2. Connect a fully charged battery pack to the model.
3. Press and release the EZ-Set button to turn the ESC on. If the LED is solid red, then the Low-Voltage Detection is DISABLED. If the LED is solid green, then Low-Voltage Detection is ACTIVATED (not safe for use with NiMH batteries).



### To disable Low-Voltage Detection (NiMH setting):

1. Make sure the LED on the ESC is on and GREEN.
2. Press and hold the EZ-Set button (the LED will turn off). After ten seconds, the motor will beep three times and the LED will shine RED. Release the button.
3. Low-Voltage Detection is now DISABLED.

## LED Codes and Protection Modes

- **Solid Red:** ESC power-on light.
- **Fast Blinking Red:** The ESC is equipped with thermal shutdown protection to guard against overheating caused by excessive current flow. If the operating temperature exceeds safe limits, the ESC will automatically shut down. Let the ESC cool.
- **Slow Blinking Red (with Low-Voltage Detection on):** The ESC has entered Low-Voltage Protection. When the battery voltage begins to reach the minimum recommended discharge voltage threshold, the ESC will limit the power output to 50% throttle. When the battery voltage attempts to fall below the minimum threshold, the ESC will shut down all motor output. The LED on the speed control will slowly blink red, indicating a low-voltage shutdown. The ESC will stay in this mode until a fully charged battery is connected.
- **Fast Blinking Green:** The ESC's LED will blink fast green if the speed control is not receiving a signal. Make certain the speed control is properly plugged into the receiver and the transmitter is switched on.
- **Flashing Red and Green:** The ESC has entered Over Voltage Protection. If a battery with too high voltage is used, the ESC will go into a failsafe mode.

Now it's time to have some fun! This section contains instructions on driving and making adjustments to your model. Before you go on, here are some important precautions to keep in mind.

- Allow the model to cool for a few minutes between runs. This is particularly important when using high-capacity battery packs that allow extended periods of running. Monitoring temperatures will extend the lives of the battery and motor.
- Do not continue to operate the model with low batteries or you could lose control of it. Indications of low battery power include slow operation and sluggish servos (slow to return to center). Stop immediately at the first sign of weak batteries. When the batteries in the transmitter become weak, the red power light will begin to flash. Stop immediately and install new batteries.
- Do not drive the model at night, on public streets, or in large crowds of people.
- The stock gear combination on each model provides good overall acceleration and top speed. For 25+mph top speeds, install the optional high-speed gearing (parts #7590X, 7591, and 7592, sold separately). The optional high-speed gearing is only intended for high-speed running on hard surfaces, and is not recommended for off-road or repetitive starting and stopping or the motor will be damaged.
- **If the model becomes stuck against an object, do not continue to run the motor. Remove the obstruction before continuing. Do not push or pull objects with the model.**
- Avoid running your model in tall grass, deep sand, or other conditions that severely limit the driving performance of the model. This will strain the power system and could cause early motor failure.
- Because the model is controlled by radio, it is subject to radio interference from many sources beyond your control. Since radio interference can cause momentary losses of control, allow a safety margin of space in all directions around the model in order to prevent collisions.
- Use good, common sense whenever you are driving your model. Intentionally driving in an abusive and rough manner will only result in poor performance and broken parts. Take care of your model so that you can enjoy it for a long time to come.
- High-performance vehicles produce small vibrations that may loosen hardware over time. Frequently check wheel bolts and other screws on your vehicle to ensure that all hardware remains properly tightened.

### About Run Time

A large factor affecting run time is the type and condition of your batteries. The milliamp hour (mAh) rating of the batteries determines how large their “fuel tank” is. A 2000 mAh battery pack will theoretically run twice as long as a 1000 mAh pack. Because of the wide variation in the types of batteries that are available and the methods with which they can be charged, it's impossible to give exact run times for the model. Another major factor that affects run time is how the model is driven. Run times may decrease when the model is driven repetitively from a stop to top-speed and with repetitive hard acceleration.

### Tips for Increasing Run Time

- Use batteries with the highest mAh rating you can purchase.
- Use the included charger or a high-quality peak-detecting charger.
- Read and follow all maintenance and care instructions provided by the manufacturer of your batteries and charger.
- Keep the speed control cool.
- Maintain your model. Do not allow dirt or damaged parts to cause binding in the drivetrain. Keep the motor clean.

### mAh Ratings and Power Output

The mAh rating of the battery can affect your top speed performance. The higher capacity battery packs experience less voltage drop under heavy load than low mAh rated packs. The higher voltage potential allows increased speed until the battery begins to become discharged.

### SHOCK MOUNTING POSITIONS

Your model is equipped with adjustable shocks with variable mounting positions so that you can tune the suspension. It is designed to handle and perform well during off-road driving. If you are going to drive on harder surfaces, move the lower shock to Position 2. The upper shock position can be adjusted and tuned to find the best setup for your driving style.

#### SHOCK POSITIONS

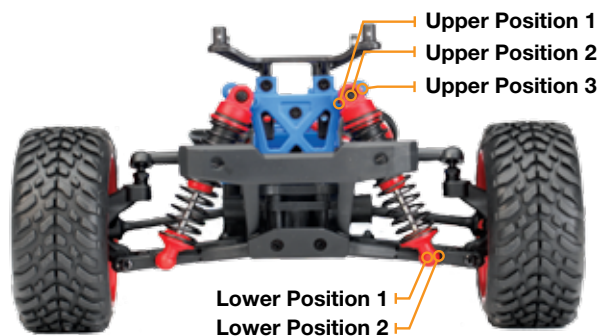



## RUNNING IN WET CONDITIONS

Your model is designed with water-resistant features to protect the electronics in the model (receiver, servos, electronic speed control). This gives you the freedom to have fun driving your model through puddles and other wet conditions. Though highly water resistant, the model should not be treated as though it is submersible or 100% waterproof. Water resistance applies only to the installed electronic components. Running in wet conditions requires additional care and maintenance for the mechanical and electrical components to prevent corrosion of metal parts and maintain their proper function.

### Precautions

- Without proper care, some parts of your model can be seriously damaged due to contact with water. Know that additional maintenance procedures will be required after running in wet conditions in order to maintain the performance of your model. Do not run your model in wet conditions if you are not willing to accept the additional care and maintenance responsibilities.
- Not all batteries can be used in wet environments. Consult your battery manufacturer to see if their batteries can be used in wet conditions.
- The LaTrax 2.4GHz transmitter is not water resistant. Do not subject it to wet conditions such as rain.
- Do NOT operate your model during a rain storm or other inclement weather where lightning may be present.
- Do NOT allow your model to come in contact with salt water (ocean water), brackish water (between fresh water and ocean water), or other contaminated water. Salt water is highly conductive and highly corrosive. Use caution if you plan to run your model on or near a beach.
- Even casual water contact can reduce the life of your motor. Special care must be taken to modify your driving style in wet conditions to extend the life of the motor (details below).

### Before Running Your Vehicle in Wet Conditions

1. Consult the section “After Running Your Vehicle in Wet Conditions” before proceeding. Make sure you understand the additional maintenance required with wet running.
2. Confirm that your batteries can be used in wet conditions.

### Motor Precautions

Motor life can be greatly reduced in water. If the motor gets excessively wet or submerged, use very light throttle (run the motor slowly) until the excess water can run out. Applying full throttle to a motor full of water can cause rapid motor failure. Your driving habits will determine motor life with wet motor. Do not submerge the motor under water.

### After Running Your Vehicle in Wet Conditions

1. Remove the battery.
2. Rinse excess dirt off the model with low-pressure water, such as from a garden hose. DO NOT use a pressure washer or other high-pressure water. Avoid directing water into the transmission, differentials, etc.
3. Blow off the model with compressed air (optional, but recommended). Wear safety glasses when using compressed air.
4. Remove the wheels from the model.
5. Spray all the bearings, bushings, and fasteners with WD-40® or similar water-displacing light oil.
6. Lubricate the drivetrain with thrust bearing grease (Traxxas Part #2717).
7. Let the model stand or you may blow off with compressed air. Placing the model in a warm, sunny spot will aid drying. Trapped water will continue to drip from the model for a few hours. Place it on a towel or piece of cardboard to protect the surface underneath.
8. As a precautionary step, remove the rubber plug from the top of the receiver box and check for trapped water or dampness. While unlikely, humidity or tiny amounts of moisture or condensation may enter the receiver box during wet running. This can cause long-term problems with the sensitive electronics in the receiver. If water is present, consider removing the receiver box during storage to allow the air inside to dry. This step can improve the long-term reliability of the receiver. To remove the receiver box, completely loosen the screws on either side of the box, lift the ESC wire out of the groove, and then carefully lift the receiver box and rotate it off to the side. It is not necessary to remove the receiver or unplug any of the wires.
9. **Additional Maintenance:** Increase your frequency of disassembly, inspection, and lubrication of the following items. This is necessary after extended wet use or if the vehicle will not be used for an extended period of time (such as a week or longer). This additional maintenance is needed to prevent any trapped moisture from corroding internal steel components.
  - **Stub axle housing bearings:** Remove, clean, and re-oil the bearings as needed.
  - **Front and rear differential:** Remove, disassemble, clean, and regrease all the gears in the differential (internal gears, ring, and pinion). Refer to your exploded view diagrams for help with disassembly and reassembly.
  - **Spur and Pinion Gears:** Remove, disassemble, and clean these components. No grease is required on the spur and pinion gear. Refer to your exploded view diagrams for help with disassembly and reassembly.

- **Motor:** Remove the motor, clean with aerosol motor cleaner, and re-oil the bushings with lightweight electric motor oil. Be sure to wear eye protection when using spray aerosol cleaners.

### MAINTAINING YOUR MODEL

Your model requires timely maintenance in order to stay in top running condition. The following procedures should be taken very seriously.

#### Inspect the vehicle for obvious damage or wear.

Look for:

1. Cracked, bent, or damaged parts
2. Check the wheels and steering for binding.
3. Check for leaks and proper operation of the shock absorbers.
4. Check the wiring for any frayed wires or loose connections.
5. Check the mounting of the receiver and servo and speed control.
6. Check the tightness of the wheel hex bolts with a wrench.
7. Check the operation of the radio system, especially the condition of the batteries.
8. Check for any loose screws in the chassis structure or suspension.
9. Inspect the gears for wear, broken teeth, or debris lodged between the teeth.
10. Check the tightness of all the pivot balls.

#### Other periodic maintenance:

- **Motor:** Every 10-15 runs, remove and clean the motor by wiping away accumulated dirt and debris from around the motor shaft bushing on the pinion gear side of the motor. Use a product such as electric motor cleaning spray to flush dirt out of the motor. After cleaning, lubricate the bushings at each end of the motor with a drop of light-weight electric motor oil.
- **Chassis:** Keep the chassis clean of accumulated dirt and grime. Periodically inspect the chassis for damage.
- **Shocks:** Keep the oil level in the shocks full. Use only 100% pure silicone shock oil to prolong the life of the seals. If you are experiencing leakage around the top of the shock, inspect the bladder in the top cap for signs of damage or distortion from overtightening. If the bottom of the shock is leaking, then it is time for a rebuild. The Traxxas rebuild kit for two shocks is part #7662.

- **Suspension:** Periodically inspect the model for signs of damage such as bent or dirty suspension pins, bent camber links, loose screws, and any signs of stress or bending. Replace components as needed.
- **Driveline:** Inspect the driveline for signs of wear such as worn drive yokes, dirty axle driveshafts, and any unusual noise or binding. Remove the gear cover, inspect the spur gear for wear, and check the tightness of the set screw in the pinion gear. Tighten, clean, or replace components as needed.



*Always wear eye protection when using compressed air or spray cleaners and lubricants.*

#### Storage

When you are through running the model for the day, blow it off with compressed air or use a soft bristled paint brush to dust-off the vehicle. Always disconnect and remove the battery from the model whenever the model is stored. If the model will be stored for a long time, then also remove the batteries from the transmitter.

Keep this manual and the other documents included with your model for future reference. If you misplace your manual or any of the documents, they may be downloaded at [LaTrax.com](http://LaTrax.com).

If you have any questions about your model or its operation, call the LaTrax Technical Support line toll-free at: **1-888-872-9927\***

Technical support is available Monday through Friday from 8:30am to 9:00pm central time.

#### ESC SPECIFICATIONS

Input Voltage:	5–6 cells NiMH (6.0–7.2V DC)
Case Size (W x D x H):	26.5 x 46.5 x 22mm
Weight:	33 grams
BEC Voltage:	6.0V DC
Power Wire:	18 Gauge / 40mm
Input Harness:	26 Gauge / 130mm
Motor Wires:	18 Gauge / 65mm

#### MOTOR SPECIFICATIONS

Size:	370, brushed
Turns:	28-turn
Voltage:	7.2V

\*Toll-free support is available to U.S. residents only; outside the U.S., please call +1972-549-3000.

# **DESERT PRERUNNER**

**OWNER'S MANUAL**

**MODEL 76064-5**



LaTrax, 6250 Traxxas Way, McKinney, Texas 75070 Phone: 972-549-3000 Toll-free 1-888-872-9927 LaTrax.com