

Interchangeable Lens Digital HD Video Camera Recorder

Operating Guide

E-mount

Table of Contents
Getting Started
Recording/Playback
Editing
Using the Menu
Connecting with another device
Troubleshooting
Additional Information
Quick Reference

NXCAM

AVCHD

InfoLITHIUM™ L SERIES

PROGRESSIVE

MEMORY STICK™

SDXC CLASS 6

HDMI

Read this first

Before operating this unit, please read this manual thoroughly, and retain it for future reference.

Notes on use

Using the camcorder

- Do not hold the camcorder by the following parts.

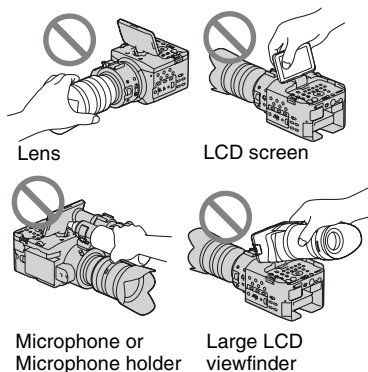

Notes

- The camcorder is not dustproof, dripproof or waterproof. See "About handling of your camcorder" (p. 107).
- When connecting the camcorder to another device with communication cables, be sure to insert the connector plug in the correct way. Pushing the plug forcibly into the terminal will damage the terminal and may result in a malfunction of the camcorder.
- Use GPS in accordance with the regulations of the situation, the countries/regions of use.

On the LCD screen and lens

- A menu item that is grayed out is not available under the current recording or playback conditions.
- The LCD screen is manufactured using extremely high-precision technology, so over 99.99% of the pixels are operational for effective use. However, there may be

some tiny black points and/or bright points (white, red, blue, or green in color) that appear constantly on the LCD screen. These points are normal results of the manufacturing process and do not affect the recording in any way.

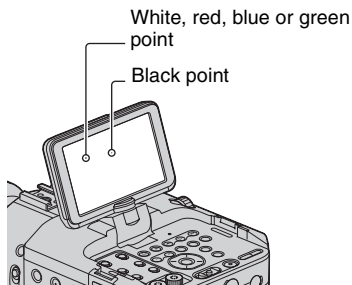

- Do not record the sun or leave the camcorder under the sun for a long time. The inside of the camcorder may be damaged. If sunlight is focused on a nearby object, it may cause a fire. When you must place the camcorder under direct sunlight, attach the front lens cap.
- Do not expose your camcorder's viewfinder, lens, or LCD screen to the sun or strong light source for extended periods. Doing so may cause a malfunction of the camcorder.
- Do not attempt to record the sun directly. Doing so may cause a malfunction of the camcorder. You may record a sunset, as the light is not as strong as that at midday.

On the temperature of your camcorder and battery pack

Your camcorder has a protective function that disables recording or playback if the temperature of your camcorder or battery pack is beyond the safely operable range. In this case, a message appears on the LCD screen (p. 97).

On recording

- In order to stabilize memory card operation, it is recommended that you format the memory card when you use it with your camcorder for the first time. All data recorded on the memory card will be erased by formatting, and cannot be recovered. Save important data on the memory card on other media such as a computer, before formatting the memory card.
- Before starting to record, test the recording function to make sure the picture and sound are recorded without any problems.
- Compensation for the loss of the content of recordings or the loss of recording opportunities cannot be provided, even if recording or playback is not possible due to a malfunction of the camcorder, storage media, etc., or even if images or sounds are distorted due to the limits of the capabilities of the camcorder.
- TV color systems differ depending on the countries/regions. To view your recordings on a TV, you need a PAL system TV.
- Television programs, films, video tapes, and other materials may be copyrighted. Unauthorized recording of such materials may be contrary to the copyright laws.
- Because of the way that the image device (CMOS sensor) reads out image signals, the following phenomena may occur.
 - The subjects passing by the frame rapidly might appear crooked depending on the recording conditions. (This phenomenon may be notable in displays having high motion resolution.)
 - Horizontal lines appear on the screen during recording under fluorescent lights. The phenomena can be reduced by adjusting the shutter speed (p. 32).
 - Images on the screen look horizontally divided when a subject is continuously lit with a flash. The effect of this phenomenon may be reduced by using a slower shutter speed. Also, you may try using the “Content

Management Utility” software on the supplied CD-ROM to repair the image.

On playing back movies

- Movies recorded using this camcorder may not play back normally on devices other than this camcorder. Also, movies recorded on other devices may not play back properly on this camcorder.
- Standard (SD) image quality movies recorded on SD memory cards cannot be played on AV devices of other manufacturers.

DVD media recorded with high definition image quality (HD)

DVD media recorded with high definition image quality (HD) can be played back with devices that are compatible with the AVCHD standard. You cannot play discs recorded with high definition image quality (HD) with DVD players/recorders as they are not compatible with the AVCHD format. If you insert a disc recorded with the AVCHD format (high definition image quality (HD)) into a DVD player/recorder, you may not be able to eject the disc.

Save all your recorded image data

- To prevent your image data from being lost, save all your recorded images on external media periodically. To save images on a computer, see page 87. To save images on an external device, see page 83.
- Movies recorded with [1080/50p PS] or [1080/50i FX] of [HD] REC FORMAT] can be saved on an external media device only (p. 83).

To handle the recorded images on your computer

Refer to “Help” on the supplied CD-ROM “Content Management Utility.”

Read this first (Continued)

Format the recording media using [MEDIA FORMAT] if images are not recorded or played back properly

If you continue recording and deleting images on recording media for a long time, the files on that recording media may be fragmented. As a result, you may not be able to record and save images properly. If this happens, save images on a separate recordable media, such as a disc or computer, then format the recording media (p. 63).

Note on disposal/transfer

Even if you format the recording media on your camcorder or computer, you may not delete data from the recording media completely. When you transfer the recording media or your camcorder, it is recommended that you delete the data completely using commercially available data deletion software to prevent the recovery of your data. Also, when you dispose of the recording media, it is recommended that you destroy the actual body of the recording media.

About the operation of the camcorder

You can operate the camcorder using the SEL/PUSH EXEC dial (p. 21, 66), $\blacktriangle/\blacktriangledown/\blacktriangleleft/\blacktriangleright$ /EXEC buttons (p. 66), and the touch panel. However, you cannot use the touch panel to make some settings such as the MENU items.

About this manual

- Operations in the manual are described using the E 18-200 mm F3.5-6.3 OSS lens supplied with the NEX-FS100EK/FS100PK. When the operation differs depending on the lens used, you will find the relevant information in “Notes” or “Tips.”
- Memory cards and a flash memory unit are both referred to as recording media in this manual.
- The images of the LCD screen used in this manual for illustration purposes are

captured using a digital still camera, and therefore may appear different.

- The on-screen displays in each local language are used for illustrating the operating procedures. Change the screen language before using your camcorder if necessary (p. 22).
- Design and specifications of recording media and other accessories are subject to change without notice.
- Illustrations of camcorders in this manual show the NEX-FS100EK/FS100PK unless otherwise specified.

About the location of the nameplate

The nameplate is located on left side of the unit (circled below).

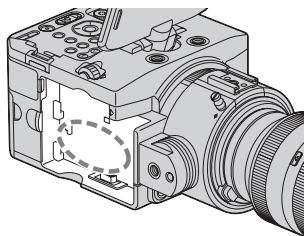

Table of Contents

Read this first	2
-----------------------	---

Getting Started

Step 1: Checking supplied items	8
Step 2: Attaching the supplied accessories	10
Step 3: Charging the battery pack	15
Step 4: Attaching the lens	18
Step 5: Turning on the camcorder and setting the date and time	21
Changing the language setting	22
Step 6: Inserting a memory card/Attaching a flash memory unit	23

Recording/Playback

Recording	26
Selecting high definition image quality (HD) or standard definition image quality (SD)	28
Selecting the recording format	28
Zooming	29
Adjusting the focus	29
Adjusting manually	31
Adjusting the iris	31
Adjusting the gain	31
Adjusting the shutter speed	32
Adjusting the white balance	33
Adjusting the black balance	34
Audio setup	35
Recording sound via the supplied microphone	36
Recording sound from an external audio device	36
Adjusting the volume	37
Setting the headphone sound	37
Useful functions	38
Customizing the picture quality (Picture profile)	38
Acquiring location information (GPS)	43
Setting time data	44
Recording with the SMOOTH SLOW REC function	45
Recording with the Slow & Quick Motion function	46
Reviewing the most recently recorded scene (Last Scene Review)	48
Assigning the functions to the ASSIGN buttons	48







Table of Contents (Continued)

Playback	50
Viewing still images	52
Changing/checking the settings in your camcorder	54
Changing the screen	54
Displaying recording data (Data code).....	54
Displaying the settings in your camcorder (Status check)	55
Connecting a monitor or a TV	56

Editing

Protecting recorded images (Protect)	58
Capturing still images from a movie	59
Dividing a movie	60
Deleting movies and still images	61
Copying movies/still images	62
Formatting the recording media	63
Preventing data on recording media from being recovered	64
Repairing the image database file	65

Using the Menu

Operating the menu	66
Menu items	68
 (CAMERA SET) menu	71
Settings to adjust your camcorder to the recording conditions (GAIN SET/STEADYSHOT, etc.)	
 (REC/OUT SET) menu	73
Recording settings, input and output settings (REC SET/VIDEO OUT)	
 (AUDIO SET) menu	74
Settings for the audio recording ( AUDIO FORMAT/XLR SET, etc.)	
 (DISPLAY SET) menu	76
Display settings (MARKER/DISPLAY OUTPUT, etc.)	
 (TC/UB SET) menu	79
Time code settings (TC PRESET/UB PRESET, etc.)	
 (OTHERS) menu	80
Settings while recording or other basic settings (AREA SET/BEEP, etc.)	

Connecting with another device

Saving images on an external media device	83
Creating a high definition image quality (HD) disc with a DVD writer	85
Creating a standard definition image quality (SD) disc with a recorder, etc.	86
Saving images with a computer	87

Troubleshooting

Troubleshooting	89
Warning indicators and messages	97

Additional Information

Recording time of movies	99
Using your camcorder abroad	101
File/folder structure on the memory card and the flash memory unit ...	102
Maintenance and precautions	103
About the AVCHD format	103
About GPS	103
About the memory card	104
About the "InfoLITHIUM" battery pack	105
About charging the battery pack	106
About handling of your camcorder	107
Specifications	110

Quick Reference

Identifying parts and controls	114
Screen indicators	120
Index	121

Step 1: Checking supplied items

Make sure that you have following items supplied with your camcorder. The number in the parentheses indicates the number of that item supplied.

All models

AC Adaptor/Charger (AC-VL1) (1) (p. 15)

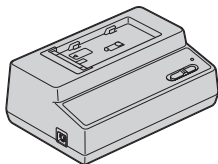

Power cord (mains lead) (1) (p. 15)



Rechargeable battery pack (NP-F770) (1) (p. 15, 105)

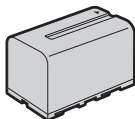

Wireless Remote Commander (RMT-845) (1) (p. 119)

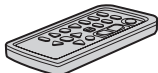

A button-type lithium battery is already installed.

Component video cable (1) (p. 56)



A/V connecting cable (1) (p. 56, 86)

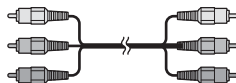

USB cable (1) (p. 87)

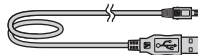

USB Adaptor Cable (1) (p. 83)



Large LCD viewfinder (1) (p. 13)

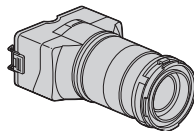

Large eyecup (1) (p. 13)



Wind Screen (1), Microphone (ECM-XM1) (1) (p. 11)

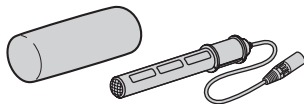

Handle (1) (p. 10)

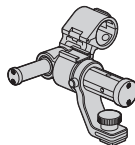

Grip (1) (p. 12)

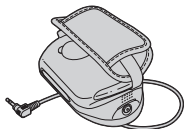

Flash memory unit jack cover (1) (p. 25)

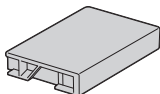

Body cap (attached to the camcorder) (1)
(p. 18)



Accessory shoe plate (1) (p. 15)



Connecting cord (DK-415) (1) (p. 17)

CD-ROM "Content Management Utility" (1)

CD-ROM "Manuals for Interchangeable
Lens Digital HD Video Camera Recorder"
(1)

Operating Guide (2)

NEX-FS100EK/FS100PK

Zoom lens (E 18-200 mm F3.5-6.3 OSS)
(1) (p. 18)



Lens hood (1) (p. 20)



Front lens cap (1), rear lens cap (1)
(attached to the lens) (p. 18)

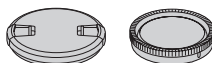

Step 2: Attaching the supplied accessories

Attaching the lens

See page 18 for information on attaching the lens. The NEX-FS100E/FS100P does not come with the E 18-200 mm F3.5-6.3 OSS lens. Please use appropriate lenses (sold separately).

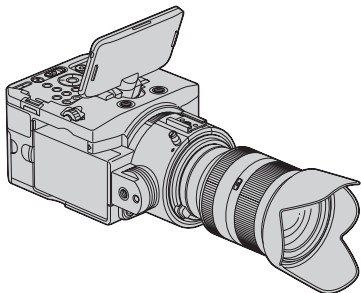

Attaching the handle

- 1 Slide the handle into the accessory shoe in the direction of the arrow.

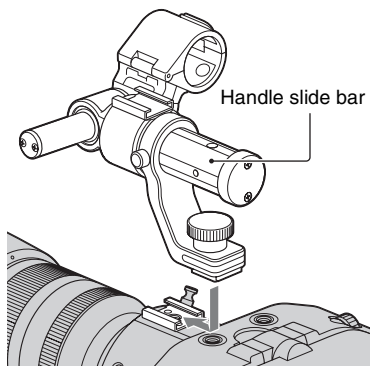

- 2 While pressing the screw down, turn it clockwise to fasten the handle.

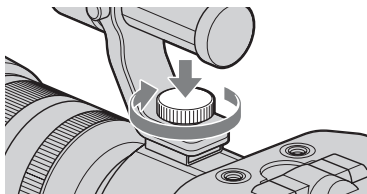

If the light to the lens is blocked

Certain types of microphone may block the light to the lens. If this happens, attach the handle facing the other way round.

- ① Remove the screws and cap of the handle slide bar, and pull the handle slide bar out.

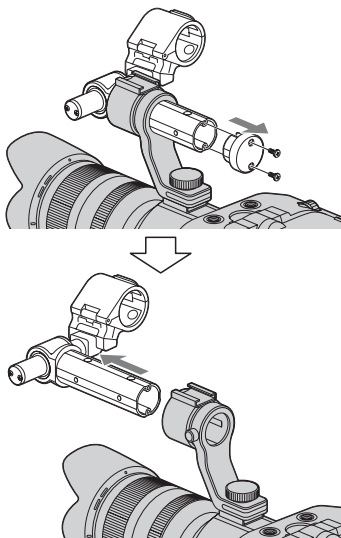

- ② Reattach the microphone holder so that it faces up.
Pull the microphone bar out. Insert the microphone bar from the opposite side.

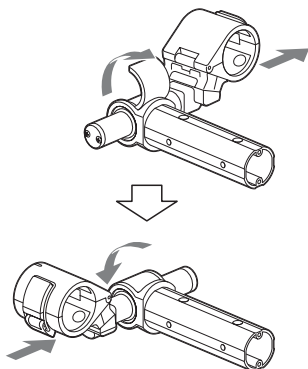

- ③ Insert the handle slide bar from the opposite side, and replace the cap and screws.

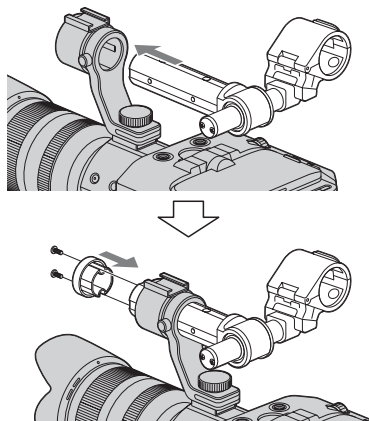

Tips

- The screw holes of the handle slide bar are for following screws.

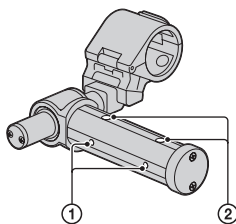

- ① For 1/4-20UNC screws
② For 3/8-16UNC screws

Attaching the microphone

Attach the microphone to the handle.

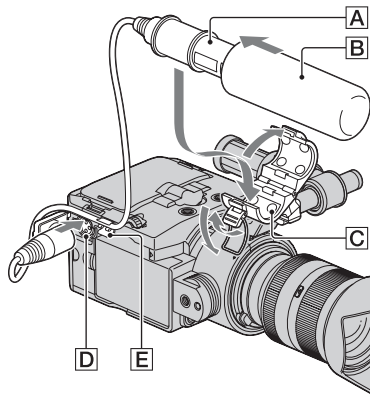

- 1 Attach the wind screen **B** to the supplied microphone **A**.
- 2 Place the microphone **A** in the microphone holder **C** with the model name facing upward, close the cover, and shut the clamp.

Step 2: Attaching the supplied accessories (Continued)

3 Connect the plug of the microphone to the INPUT 1 jack **D**.

Put the microphone cable into the cable clamp **E**.

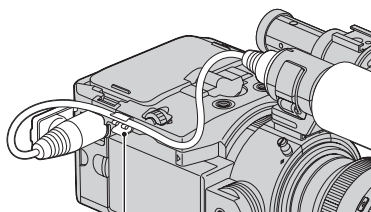

Cable clamp

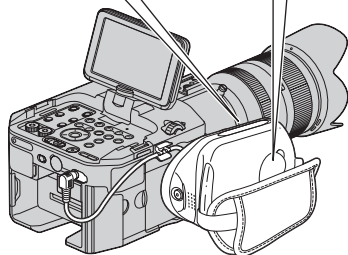
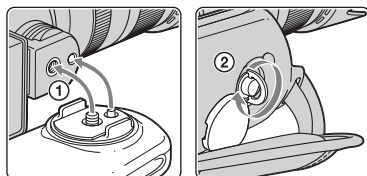

Attaching the grip

You can rotate the grip to suit shooting angles.

1 Align the grip receptacle **1** and locating hole of the camcorder with the screw and boss of the grip. Choose the grip angle, and fasten the grip securely by turning the knob **2** clockwise.

2 Connect the cable to the REMOTE jack.

Connecting the cable allows you to start/stop recording by using the record button on the grip.

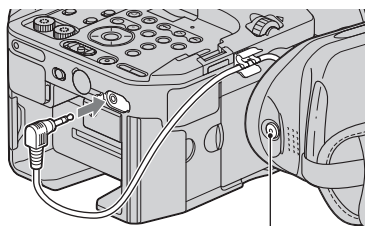

Record button

When changing the grip angle

Unfasten the knob, adjust the angle, then tighten the knob.

Attaching the large LCD viewfinder

Attach the large LCD viewfinder to the LCD screen.

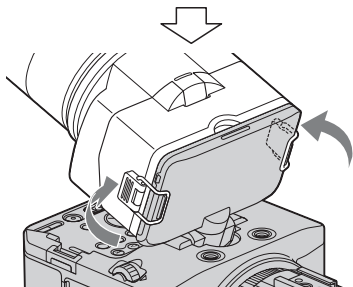
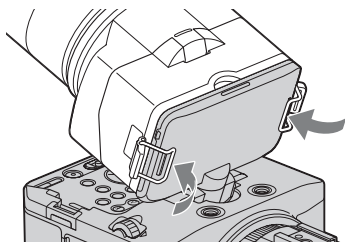

You can use the viewfinder in the following 2 ways, depending on your shooting angle.

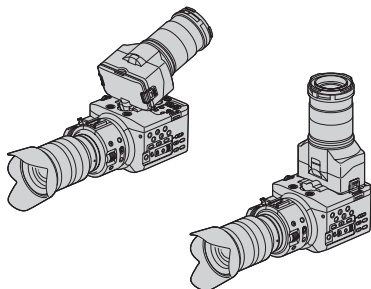

💡 Tips

- You can set and hold the LCD screen angle (p. 14).

Adjusting the viewfinder lens

Turn the viewfinder lens adjustment ring so that you can see the image on the LCD screen clearly.

Viewfinder lens adjustment ring
Turn it until the picture becomes clear.

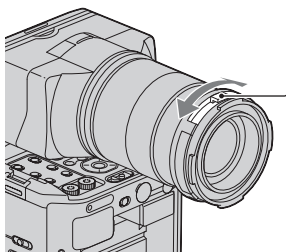

When the picture on the LCD screen is hard to see

If you cannot see the picture on the LCD screen clearly under bright circumstances, use the supplied large eyecup. To attach the large eyecup, stretch it slightly and align it with the groove in the large LCD viewfinder. You can attach the large eyecup facing either the right or left side.

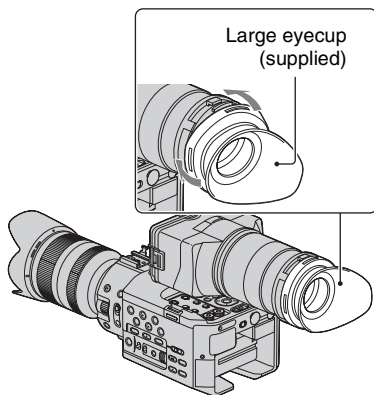

Step 2: Attaching the supplied accessories (Continued)

Tips

- If you are farsighted and have a trouble seeing images on the camcorder screen, you can attach a 52 mm close-up lens (sold separately) to the viewfinder lens adjustment ring.

Using the tape measure hook

The tape measure hook is attached at the image sensor position.

When you want to measure the precise distance between the image sensor and the subject, hook the end of a tape measure here.

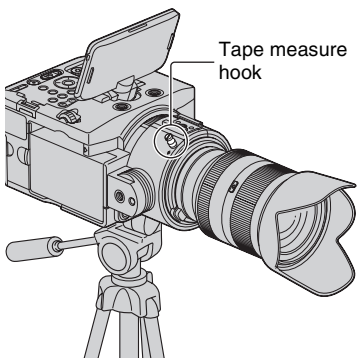

Using the LCD screen

The LCD panel is placed above the centerline of the lens, on the same angle as the lens views the subject, so the subject will be captured as you see it. The LCD screen can be rotated right or left, allowing a person other than the camera operator to see the image.

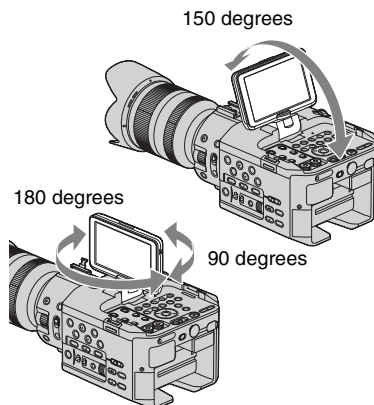

You can set and hold the LCD screen angle by turning the LCD HOLD dial.

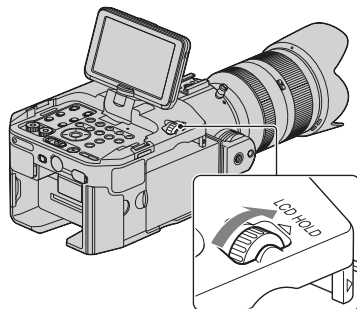

Loosen the LCD HOLD dial when you change the angle.

Using the accessory shoe

When attaching an accessory other than the handle, attach the accessory shoe plate to the accessory shoe.

Attaching the accessory shoe plate

Insert the accessory shoe plate in the direction of the arrow on the plate surface until the end of the plate engages the end of the shoe.

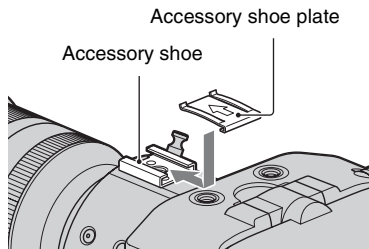

Step 3: Charging the battery pack

You can charge the “InfoLITHIUM” battery pack (L series) with the supplied AC Adaptor/Charger.

Notes

- You can use a large capacity battery back, NP-F770 (supplied) or NP-F970 (sold separately), with your camcorder. You cannot use NP-F570.

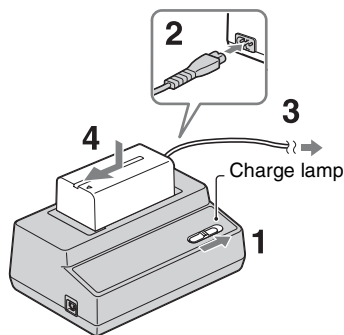

- 1 Set the mode switch to CHARGE.
- 2 Connect the power cord (mains lead) to the AC Adaptor/Charger.
- 3 Connect the power cord (mains lead) to the wall outlet (wall socket).
- 4 Place the battery pack in the slot of the AC Adaptor/Charger, press it down, and slide it in the direction of the arrow as illustrated.

The charge lamp turns on and charging starts.

Step 3: Charging the battery pack (Continued)

After charging the battery

The charge lamp turns off (normal charge). If you continue charging more 1 hour after the charge lamp turns off, you can use the battery a little longer (full charge). Remove the battery pack from the AC Adaptor/Charger when the charge is completed.

To attach the battery pack

Press the battery pack against the back of your camcorder and slide it right as shown below.

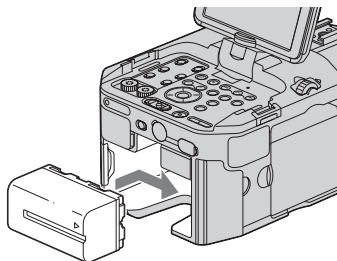

Tips

- You can check the remaining battery life with the status check function (p. 55).

To remove the battery pack

Slide the POWER switch to OFF. Push the BATT RELEASE (battery release) button and slide the battery pack as shown below.

BATT RELEASE button

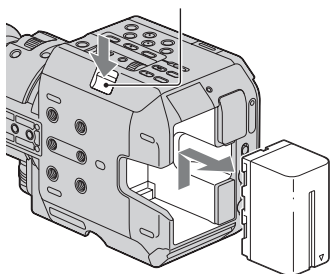

To store the battery pack

If the battery pack is not in use for a while, run down the battery and store it. See page 106 for details on storage of the battery pack.

Charging time

Approximate time (minute) required when you charge a fully discharged battery pack.

Battery pack	Normal charge time	Fully charge time
NP-F770	250	310
NP-F970	365	425

Notes

- The supplied battery pack is NP-F770.
- You cannot use the NP-F570 battery pack with your camcorder.

On the battery pack

- Before changing the battery pack, slide the POWER switch to OFF.
- The Battery Info (p. 55) will not be correctly displayed under the following conditions.
 - The battery pack is not attached correctly.
 - The battery pack is damaged.
 - The battery pack is worn-out.

Using an outside power source

By using the AC Adaptor/Charger and the connecting cord DK-415 (supplied), you can use the camcorder on AC power, without worrying about running out of power.

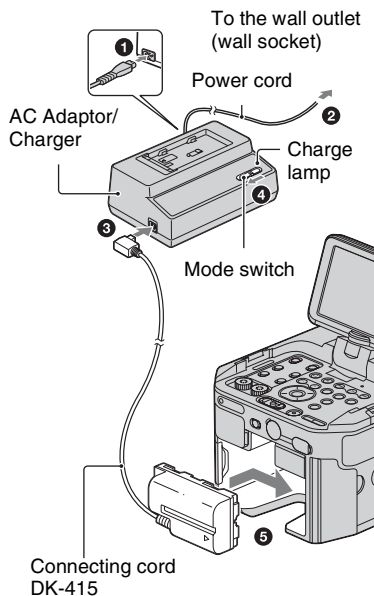

- ① Connect the power cord (mains lead) to the AC Adaptor/Charger.
- ② Connect the power cord (mains lead) to the wall outlet (wall socket).
- ③ Connect the connecting cord (DK-415) to the AC Adaptor/Charger.
- ④ Set the mode switch of the AC Adaptor/Charger to VCR/CAMERA.
- ⑤ Press the connecting part of the connecting cord (DK-415) against the back of your camcorder in the battery slot and slide it in the direction of the arrow.

On the AC Adaptor/Charger

- Use the nearby wall outlet when using the AC Adaptor/Charger. Disconnect the AC Adaptor/Charger from the wall outlet (wall socket) immediately if any malfunction occurs while using your camcorder.
- Do not use the AC Adaptor/Charger placed in a narrow space, such as between a wall and furniture.
- Do not short-circuit the DC plug of the AC Adaptor/Charger or battery terminal with any metallic objects. This may cause a malfunction.
- Even if your camcorder is turned off, AC power (house current) is still supplied to it while connected to the wall outlet (wall socket) via the AC Adaptor/Charger.

Step 4: Attaching the lens

This manual explains how to attach a lens using the E18-200 mm F3.5-6.3 OSS lens that comes with NEX-FS100EK/FS100PK.

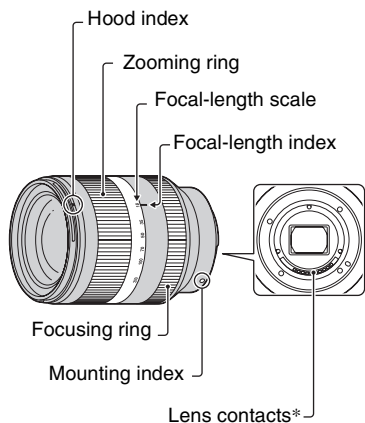
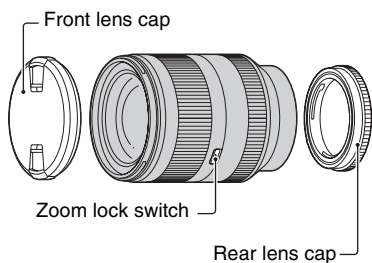

* Do not touch or dirty the lens contacts.

Attaching the lens

Hold the camcorder body with the front end downward, and quickly change the lens somewhere away from dusty locations so as to keep dust or debris from getting inside the camcorder body.

- 1 Remove the body cap from the camcorder body and the packaging lid from the rear of the lens.**

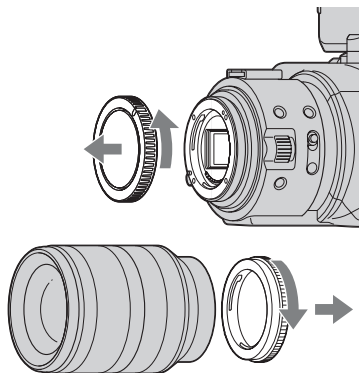

- 2 Mount the lens by aligning the mounting indexes (white) on the lens and the camcorder body. While pushing the lens lightly toward the camcorder body, turn the lens clockwise until it clicks into the locked position.**

Be sure to put the lens on straight.

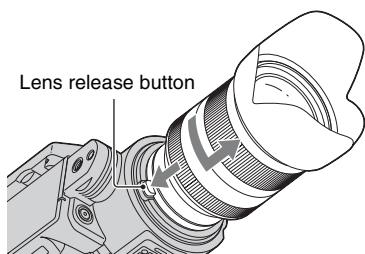
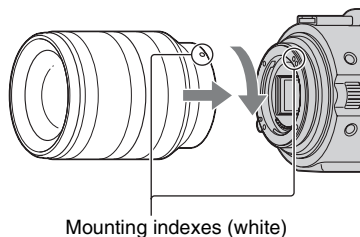

Notes

- When attaching a lens, do not press the lens release button.
- Do not use force when attaching a lens. Mounting the lens forcibly may result in a malfunction or damage of the lens mount.
- There may be a gap between the lens and the lens mount, depending on the lens attached. This is normal.

Tips

- When you have changed the lens, it is recommended to adjust the black balance (p. 34) before recording. When you adjust the black balance, make sure that the front lens cap is attached.

Removing the lens

1 While pressing the lens release button all the way in, turn the lens counterclockwise until it stops.

- When you remove the lens, make sure that you hold both of the lens and the camcorder body.

2 Replace the packaging lid on the lens and attach the body cap to the camcorder body.

- Align the mark on the body cap to the mounting indexes, and turn the cap clockwise.

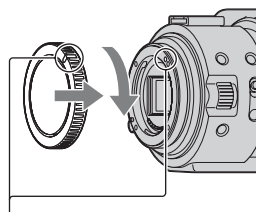

- Before you attach caps, remove dust from them.

Notes

- When changing the lens, if dust or debris gets inside the camcorder body and adheres to the surface of the image sensor (the part that acts as the film), it may appear on the image, depending on the shooting conditions. The image sensor is applied with the anti-dust coating, to prevent dust from adhering to the image sensor. However, attach or remove the lens quickly somewhere away from dusty locations.
- Do not leave the camcorder body with the lens and body cap removed.

Step 4: Attaching the lens (Continued)

If dust or debris adheres on the image sensor

Turn off the camcorder and detach the lens. Clean the image sensor and the surrounding area using a blower (sold separately), and then reattach the lens.

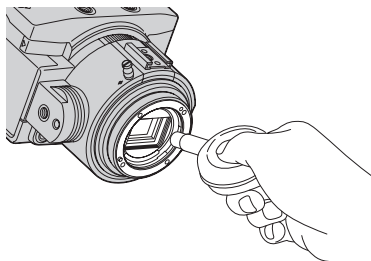

Notes

- Do not use a spray blower because it may scatter water droplets inside the camcorder body.
- Do not put the tip of a blower into the cavity beyond the mount, so that the tip of the blower does not touch the image sensor.
- Hold the camcorder's face downward to prevent the dust from resettling in the camcorder.
- Do not apply a mechanical shock to the camcorder during cleaning.
- If you cannot clean the image sensor by the above procedure, consult your Sony dealer or local authorized Sony service facility.

A-mount lenses

- You need a Mount Adaptor (sold separately) to use A-mount lenses. For details, refer to the operating manuals that come with the Mount Adaptor.
- When an A-mount lens is attached, you cannot use the auto focus and auto iris functions. You may not be able to use certain A-mount lenses. For the compatibility of a particular A-mount lens, visit the Sony website in your area, or consult your Sony dealer or local authorized Sony service facility.

To attach the lens hood

Align the red line of the lens hood to that of the lens and mount the lens hood on the lens. Turn the lens hood clockwise until the red dot of the lens hood and the red line of the lens align with a click.

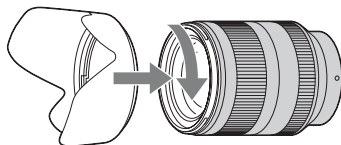

When storing the lens, fit the lens hood onto the lens backwards.

Step 5: Turning on the camcorder and setting the date and time

Turning on the camcorder

Slide the **POWER** switch to **ON** while you press the **green button**.

When you use your camcorder for the first time, the [CLOCK SET] screen appears.

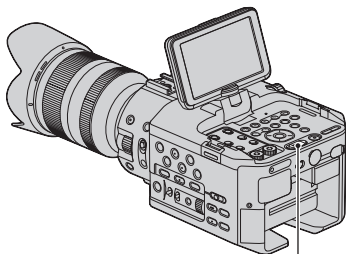

Press and hold the green button.

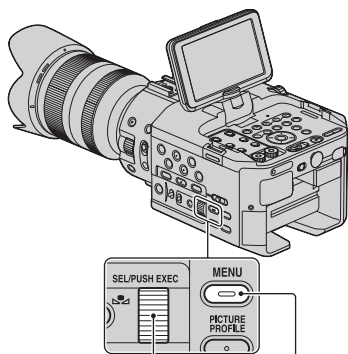
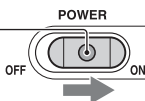

SEL/PUSH EXEC dial

MENU button

Skip to step 4 when you set the clock for the first time.

1 Press the **MENU** button.

2 Select **OTHERS** (OTHERS) by turning the SEL/PUSH EXEC dial, then press the dial.

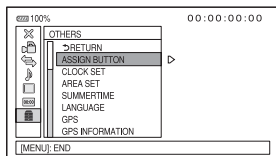

3 Select **[CLOCK SET]** by turning the SEL/PUSH EXEC dial, then press the dial.

To turn off the power

Slide the **POWER** switch to **OFF**.

Notes

- If warning messages appear on the screen, follow the instructions.

Setting the date and time

Set the date and time when you use your camcorder for the first time.

Tips

- If you do not use your camcorder for **about 3 months**, the built-in rechargeable battery gets discharged and the date and time settings may be cleared from the memory. In that case, charge the rechargeable battery and then set the date and time again (p. 108).

Step 5: Turning on the camcorder and setting the date and time (Continued)

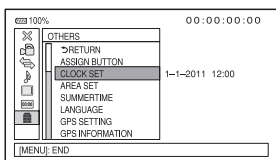

the correct time automatically, depending on the country/region selected for your camcorder. In this case, set [AUTO CLOCK ADJ] and [AUTO AREA ADJ] to [OFF].

Changing the language setting

You can change the on-screen displays to show messages in a specified language. Press the MENU button and select  (OTHERS) with the SEL/PUSH EXEC dial. Select the screen language in [LANGUAGE] (p. 80).

4 Select your area by turning the SEL/PUSH EXEC dial, then press the dial.

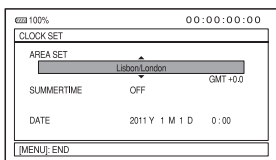

5 Set [SUMMERTIME], [Y] (year), [M] (month), [D] (day), hour and minute, by turning the SEL/PUSH EXEC dial, then press the dial.

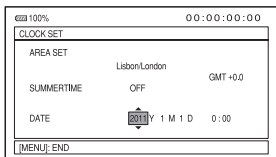

The clock starts.

- Set [SUMMERTIME] to [ON] to move the time forward 1 hour.
- You can set any year up to the year 2037.

Tips

- The date and time are automatically recorded on the selected recording media, and can be displayed during playback (DATA CODE button, p. 54).
- Once the clock is set, the clock time is automatically adjusted with [AUTO CLOCK ADJ] (p. 81) and [AUTO AREA ADJ] (p. 81) set to [ON]. The clock may not be adjusted to

Step 6: Inserting a memory card/Attaching a flash memory unit

Memory card

Types of memory cards you can use in your camcorder

	SD Speed Class	Described in this manual
“Memory Stick PRO Duo” media (Mark2)	-	“Memory Stick PRO Duo” media
“Memory Stick PRO-HG Duo” media	-	“Memory Stick PRO Duo” media
SD memory card	Class 4 or faster	SD card
SDHC memory card		
SDXC memory card*		

Types of memory cards you can use with Slow & Quick Motion recording

	SD Speed Class	Described in this manual
“Memory Stick PRO-HG Duo” media	-	“Memory Stick PRO Duo” media
SD memory card	Class 10 or faster	SD card
SDHC memory card		
SDXC memory card*		

* Movies recorded on SDXC memory cards cannot be imported to or played back on computers or A/V devices not supporting the exFAT file system, that is used for SDXC memory cards, by connecting the camcorder to these devices with the USB cable. Confirm in advance that the connecting equipment is supporting the exFAT system. If you connect equipment not supporting the exFAT system and the format screen appears, do not perform the format. All the data recorded will be lost.

🔗 Notes

- Operation with all memory cards is not assured.
- “Memory Stick PRO Duo” media, half the size of “Memory Stick” media, or standard size SD cards can be used for this camcorder.
- Do not attach a label or the like on memory card or memory card adaptor. Doing so may cause a malfunction.
- “Memory Stick PRO Duo” media of up to 32 GB and SD cards of up to 64 GB have been verified to operate with your camcorder.
- See page 99 for the recordable time of memory cards.
- A MultiMedia Card cannot be used with this camcorder.

Step 6: Inserting a memory card/Attaching a flash memory unit (Continued)

- 1 Open the cover in the direction of the arrow.

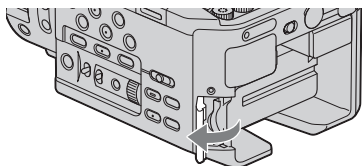

- 2 Insert the memory card with the notched edge in the direction as illustrated until it clicks.

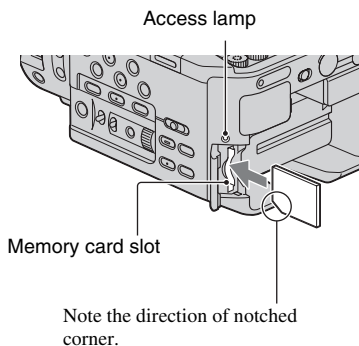

⚡ Notes

- If you insert a memory card into the slot in the wrong direction, the memory card, the memory card slot, or image data may be damaged.

To eject the memory card

Lightly push the memory card once.

⚡ Notes

- When the access lamp is lit or flashing in red, your camcorder is reading/writing data. Do not shake or knock your camcorder, turn the power

off, eject the memory card, or remove the battery pack. Otherwise, image data may be damaged.

- If [The image database file is corrupted. The media must be restored to use again.] appears in step 2, format the memory card (p. 63).
- When inserting or ejecting the memory card, be careful to prevent the memory card from popping out and dropping.

Flash memory unit

You can attach a flash memory unit HXR-FMU128 (sold separately) to your camcorder for recording movies.

While sliding the **RELEASE** lever, align the mark on the camcorder with the one on the flash memory unit, and slide the flash memory unit in the direction of the arrow.

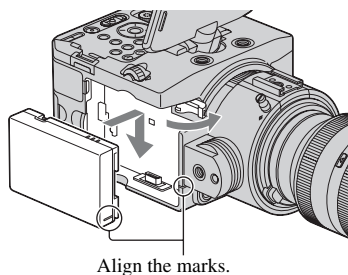

To remove the flash memory unit

Turn off your camcorder, and while sliding the **RELEASE** lever in the direction of arrow, remove the flash memory unit.

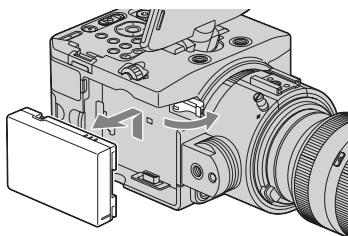

When you do not use a flash memory unit

Leave the flash memory unit jack cover attached.

While sliding the **RELEASE** lever in the direction of the arrow, attach the flash memory unit jack cover.

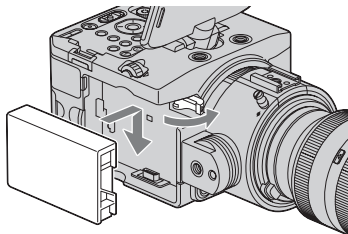

💡 Tips

- Your camcorder does not have the relay recording function. If the memory card is fully recorded during recording, the camcorder stops recording automatically.
- You can record movies on both of the memory card and the flash memory unit simultaneously (p. 27).

Recording

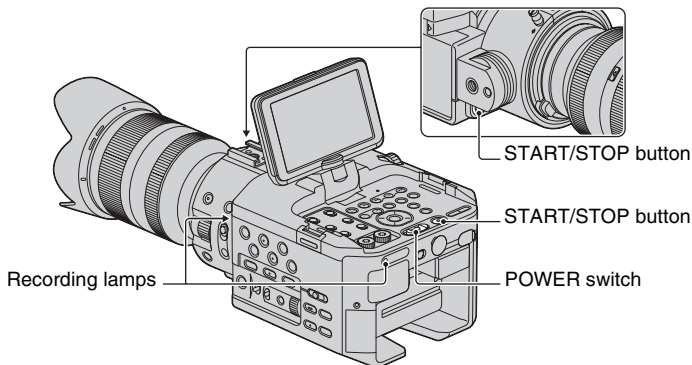

Your camcorder records movies on a memory card and/or a flash memory unit. Do the following steps to record movies.

- This camcorder can record movies in either high definition image quality (HD) or standard definition image quality (SD). The factory setting is high definition image quality (HD) ([**HD**]/[**SD**] SET], p. 28).

⚠ Notes

- When the access lamp is lit or flashing in red, your camcorder is writing data on recording media. Do not shake or knock your camcorder, or remove the battery pack or the AC Adaptor/Charger.
- See page 99 on the recording time of movies.
- Your camcorder can record a movie for about 13 hours continuously.
- If a movie file exceeds 2 GB during recording, the camcorder divides the file and create a new file automatically.
- The menu settings, the PICTURE PROFILE settings, and the settings made by the AUTO/MANUAL switch are stored in your camcorder when you slide the POWER switch to OFF. The access lamp lights up while the settings are being stored. If you remove the battery pack or the AC Adaptor/Charger before turning off the power, the settings may return to the default settings.

1 Slide the POWER switch to ON while pressing the green button.

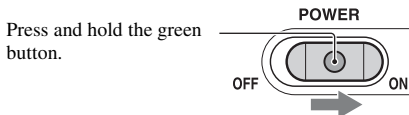

Press and hold the green button.

2 Press the START/STOP button.

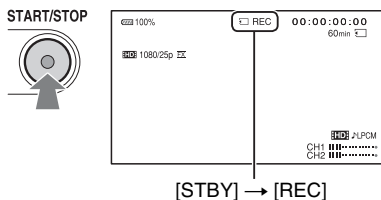

The recording lamp lights up during recording.

To stop the movie recording, press the START/STOP button again.

💡 Tips

- When recording in high definition image quality (HD), the aspect ratio is fixed to 16:9. When recording in standard definition image quality (SD), you can switch the aspect ratio to 4:3 ([**SD**] WIDE REC], p. 73).
- You can change the screen display during recording (p. 54).
- Indicators displayed on the screen during recording are shown on page 120.
- The recording lamp can be set to stay off ([REC LAMP[F]], [REC LAMP[R]], p. 82).
- You can capture still images from the movies you recorded (p. 59).

To record movies using both the memory card and the flash memory unit (Simultaneous recording)

You can record movies on both of these recording media simultaneously.

Press MENU → select **REC/OUT SET** → [REC SET] → [**HD**] SIMULTANEOUS REC] → [ON] (default setting) with the SEL/PUSH EXEC dial.

💡 Tips

- Set [**HD**] / [**SD**] SET] to [**HD**] (p. 28) for the simultaneous recording.
- If one of the recording media used becomes unable to continue recording during simultaneous recording, the other recording media continues recording without pause.
- When [**HD**] SIMULTANEOUS REC] is [ON], movies are recorded on both media, irrespective of the [**HD**] REC MEDIA SETTING] setting.

To record movies only on the memory card or the flash memory unit

- ① Press MENU → select **REC/OUT SET** → [REC SET] → [**HD**] SIMULTANEOUS REC] → [OFF].
- ② Select **REC/OUT SET** → [REC SET] → [**HD**] REC MEDIA SETTING] → [MEMORY CARD] or [FMU] (flash memory unit).

💡 Tips

- A message appears if an access error occurred while the camcorder was accessing the recording media. During simultaneous recording, the [STBY] indicator and the icon of the recordable medium appears on the screen.

Selecting high definition image quality (HD) or standard definition image quality (SD)

You can select the desired image quality from the high definition image quality (HD) that enables you to record fine images, or the standard definition image quality (SD) that has more compatibility with various playback devices ([HD] is the default setting). Change the image quality according to the recording situation or the playback device.

To change the setting

Press MENU → select  (REC/OUT SET) → [REC SET] → [**[HD]**/**[SD]** SET] → [**[HD]**] or [**[SD]**] with the SEL/PUSH EXEC dial.

Selecting the recording format

You can select the recording format (bit-rate, image size, frame rate, scanning system). In the default setting, [**[HD]** 1080/25p **[FX]**] is selected.

To change the setting

Press MENU → select  (REC/OUT SET) → [REC SET] → [**[HD]** REC FORMAT] → a desired format with the SEL/PUSH EXEC dial.

Setting value	Description
1080/50p [PS]	<ul style="list-style-type: none"> • Bit-rate PS: max. 28 Mbps FX: max. 24 Mbps FH: approx. 17 Mbps (average) HQ: approx. 9 Mbps (average) LP: approx. 5 Mbps (average)
1080/50i [FX]	
1080/50i [FH]	
1080/50i [HQ]	
1080/50i [LP]	<ul style="list-style-type: none"> • Image size PS: 1920×1080 FX: 1920×1080/1280×720 FH: 1920×1080/1280×720 HQ: 1440×1080 LP: 1440×1080
1080/25p [FX]	
1080/25p [FH]	<ul style="list-style-type: none"> • Frame rate either 25 or 50
720/50p [FX]	
720/50p [FH]	<ul style="list-style-type: none"> • Scanning system i: interlace p: progressive

Setting value

If you select [1080/25p FX], for example, movies are recorded with following format.

- 1080: Effective scanning lines
- 25: Frame rate
- p: Scanning system
- FX: Recording mode

Notes

- The recording mode is fixed to FX or FH with the progressive scanning system.
- You can save movies that have been recorded with [1080/50p PS] or [1080/50i FX] of [HD: REC FORMAT] on an external media device only (p. 83).

Tips

- The recording format of [576/50i HQ] is automatically selected for the standard image quality (SD) recording.

Zooming

Turn the zooming ring right or left to decide on the size of the subject in your image. Zooming must be done before focusing.

Notes

- The operations and operating methods available depend on the lens attached. Refer to the operating manuals that comes with your lens.
- Do not grab or apply a strong force to the lens cylinder that rolls out when zooming. The lens may be damaged.

Adjusting the focus

You can adjust the focus manually for different recording conditions.

Use this function in the following cases.

- To record a subject behind a window covered with raindrops.
- To record horizontal stripes.
- To record a subject with little contrast between the subject and its background.
- When you want to focus on a subject in the background.

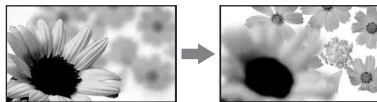

- To record a stationary subject using a tripod.

Recording (Continued)

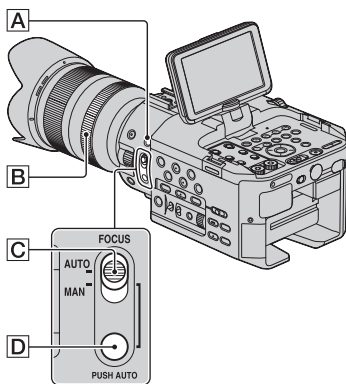

Notes

- When you use A-mount lenses (sold separately), you cannot use following functions and buttons.
 - Auto focus
 - Button **D**
 - FOCUS switch **C** at the AUTO position

1 During recording or standby, set the FOCUS switch **C** to MAN.

appears.

2 Rotate the focusing ring **B** and adjust the focus.

changes to when the focus cannot be adjusted any farther. changes to when the focus cannot be adjusted any closer.

Tips

For focusing manually

- It is easier to focus on the subject when you use the zoom function. Zoom towards T (telephoto) to adjust the focus, and then, towards W (wide angle) to adjust the zoom for recording.

- When you want to record a close-up image of a subject, fully zoom out towards W (wide angle), then adjust the focus.

To restore automatic adjustment

Set the FOCUS switch **C** to AUTO. disappears and the automatic focus adjustment is restored.

Using automatic focus temporarily (Push auto focus)

Record the subject while pressing and holding the PUSH AUTO button **D**. If you release the button, the setting returns to manual focusing.

Use this function to shift the focus on one subject to another. The scenes will shift smoothly.

Tips

- The focal distance information (for when it is dark and hard to adjust the focus) appears for about 3 seconds in the following cases.
 - When you set the FOCUS switch **C** to MAN and appears on the screen.
 - When you rotate the focusing ring while is displayed on the screen.

Using the expanded focus (Expanded focus)

Press the EXPANDED FOCUS button **A**. [EXPANDED FOCUS] appears and the center of the screen is magnified by about 2.0 times. It will be easier to confirm the focus setting during manual focusing. The screen returns to the original size when you press the button again.

Notes

- Even though the image appears expanded on the screen, the recorded image is not expanded.
- You cannot use the expanded focus with the SMOOTH SLOW REC function (p. 45).

Adjusting manually

Set the AUTO/MANUAL switch to MANUAL when you adjust the iris, gain, shutter speed, and white balance manually.

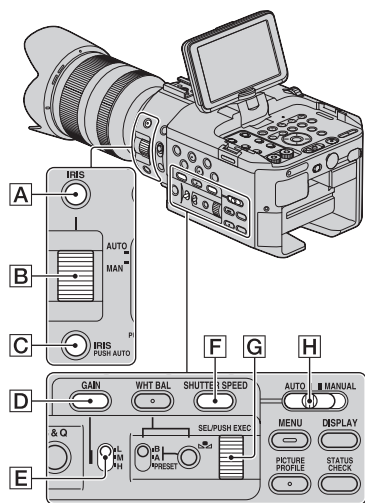

Adjusting the iris

This is handy for making the background blurred or sharp.

1 Set the AUTO/MANUAL switch **[H]** to MANUAL.

2 Press the IRIS button **[A]**.
[A] next to the iris value disappears.

3 Adjust the iris with the iris ring **[B]**.

The volume of the light increases the more that you open the aperture (decreasing F value). The volume of the

light decreases the more that you close the aperture (increasing F value).

To temporarily adjust the iris automatically

Hold the IRIS PUSH AUTO button **[C]** down.

The iris is adjusted automatically for as long as you hold the button down

To adjust the iris automatically

Press the IRIS button **[A]**.

[A] appears next to the iris value.

Notes

- You can make this adjustment only with an E-mount lens.
- When you use A-mount lenses (sold separately), you must adjust the iris manually, using the iris ring **[B]**.
- When you set the AUTO/MANUAL switch **[H]** to AUTO, iris, gain, shutter speed, and white balance are adjusted automatically. You cannot adjust any of them manually.

Tips

- The range of focus, an important effect of the aperture, is called the depth of field. The depth of field gets shallower as the aperture is opened, and deeper as the aperture is closed. Use the aperture creatively to obtain the desired effect in your photography.

Adjusting the gain

You can adjust the gain manually when you do not want to use the AGC (automatic gain control).

1 Set the AUTO/MANUAL switch **[H]** to MANUAL.

2 Press the GAIN button .

 next to the gain value disappears, or the gain value appears on the screen.

3 Set the gain switch to H, M or L.

The gain value set for the selected gain switch position appears on the screen. You can set the gain value for each gain switch position from [GAIN SET] of the  (CAMERA SET) menu (p. 71).

To adjust the gain automatically

Press the GAIN button .

The gain value disappears, or  appears next to the gain value.

Notes

- When you set the AUTO/MANUAL switch  to AUTO, iris, gain, shutter speed, and white balance are adjusted automatically. You cannot adjust any of them manually.

Adjusting the shutter speed

You can manually adjust and fix the shutter speed. You can make a moving subject look still or emphasize the movement of a moving subject by adjusting the shutter speed.

1 Set the AUTO/MANUAL switch to MANUAL.

2 Press the SHUTTER SPEED button until the shutter speed value is highlighted.

3 Change the shutter speed displayed on the screen by turning the SEL/PUSH EXEC dial .

You can adjust the shutter speed in a range of 1/3 second through 1/10000 second.

The denominator of the set shutter speed appears on the screen. For example, [100] appears on the screen when you set the shutter speed to 1/100 second. The larger the value on the screen is, the faster the shutter speed is.

4 Press the SEL/PUSH EXEC dial to lock the shutter speed.

To readjust the shutter speed, repeat steps from 2.

Tips

- It is difficult to focus automatically at a lower shutter speed. Manual focusing with your camcorder attached to a tripod is recommended.
- When recording under fluorescent lamps, sodium lamps, or mercury lamps, the picture may flicker or change colors, or may have horizontal bands of noise. You may be able to improve the situation by adjusting the shutter speed.

To adjust the shutter speed automatically

Press the SHUTTER SPEED button  twice.

The shutter speed value disappears, or  appears next to the shutter speed value.

Notes

- When you set the AUTO/MANUAL switch  to AUTO, iris, gain, shutter speed, and white balance are adjusted automatically. You cannot adjust any of them manually.

Adjusting the white balance

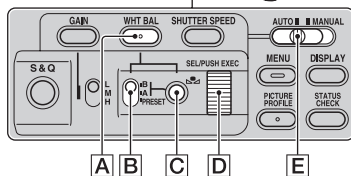
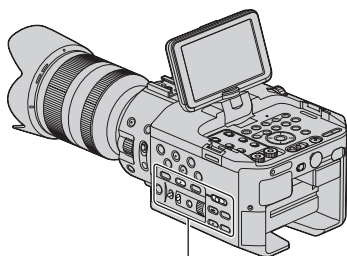

You can adjust and fix the white balance according to the lighting conditions of recording environment.

You can store white balance values in memory A (A) and memory B (B), respectively. Unless a white balance is readjusted, values will remain even after the power has been turned off.

When you select PRESET, [OUTDOOR], [INDOOR] or [MANU WB TEMP] is selected, according to which one you previously set with [WB PRESET] in the  (CAMERA SET) menu.

Tips

- You can assign [WB PRESET] to an ASSIGN button (p. 48).

1 Set the AUTO/MANUAL switch to MANUAL.

2 Press the WHT BAL button .

3 Set the white balance memory switch to any one of PRESET/A/B.

Select A or B for recording with the white balance setting stored in memory A or B.

■ To use the white balance you adjusted in advance



- ① Preset the white balance offset value as described in “To save the adjusted white balance value in memory A or B” (p. 34).
- ② Set the white balance memory switch  to A or B.

Tips



- This adjustment is recommended when you use a commercially available ND filter.

■ To use the preset white balance offset value

Outdoor recording

- ① Select [CAMERA SET] menu → [WB PRESET] →  (OUTDOOR) (p. 71).
- ② Set the white balance memory switch  to PRESET.

Indoor recording

- ① Select [CAMERA SET] menu → [WB PRESET] →  (INDOOR).
- ② Set the white balance memory switch  to PRESET.



■ To set the color temperature

- ① Select [CAMERA SET] menu → [WB TEMP SET] → a desired color temperature (p. 71).
- ② Select [CAMERA SET] menu → [WB PRESET] → [MANU WB TEMP] (p. 71).





Adjusting manually (Continued)

- Set the white balance memory switch **[B]** to PRESET.



Tips

- You can change the outdoor white balance setting by setting an offset value. Press  (one push) button **[C]** while  (outdoor) is selected and turn the SEL/PUSH EXEC dial **[D]** to select an offset value from -7 (bluish) to 0 (normal, the default setting) to +7 (reddish). You can also set the white balance offset value from the menu ([WB OUTDOOR LEVEL], p. 71).
- You can change the color temperature. Set [WB PRESET] to [MANU WB TEMP], and the white balance memory switch **[B]** to PRESET, then press the  (one push) button **[C]**. Turn the SEL/PUSH EXEC dial **[D]** until the desired temperature appears on the screen, then press the dial to set the temperature.

To save the adjusted white balance value in memory A or B

- Set the AUTO/MANUAL switch **[E]** to MANUAL.
- Press the WHT BAL button **[A]**.
- Set the white balance memory switch to A ( A) or B ( B).
- Capture a white subject, such as white paper, full-screen in the same lighting condition as the one in which the subject is.
- Press the  (one push) button **[C]**. The adjusted value is stored in  A or  B. The stored color temperature appears for about 3 seconds.

Notes

- When a white balance adjustment value has not been obtained successfully,  A or  B turns to slow flashing. Adjust the subject appropriately and set the shutter speed to auto or around 1/50, then try adjusting the white balance again.
- It may take a long time to adjust the white balance, depending on the recording conditions. If you want to perform a different operation

before completing the adjustment, set the white balance memory switch **[B]** to another position to temporarily suspend white balance adjustment.

To adjust the white balance automatically

Press the WHT BAL button **[A]**.

Notes

- When you set the AUTO/MANUAL switch **[E]** to AUTO, other manual adjusted items (iris, gain, and shutter speed) also become automatic.

Adjusting the black balance

Normally, you do not need to adjust the black balance.

The black balance may be inappropriately adjusted for some recording situations. If that happens, adjust the black balance. It is recommended that you adjust the black balance also when you change the lens. The adjusted settings are stored only temporarily. The settings return to the default settings when you turn the power off.

1 Press the MENU button during standby.

2 Select  (CAMERA SET) → [BLACK BALANCE] with the SEL/PUSH EXEC dial.

3 Following the message on the screen, attach the front lens cap, and select [YES].

The black balance adjustment starts.

Audio setup

4 When [Completed.] appears, press the MENU button to complete the adjustment.

If [Could not adjust.] appears

Try the adjustment again.

The following jacks and switches allow you to set the sound to be recorded. See page 11 on connecting the microphones.

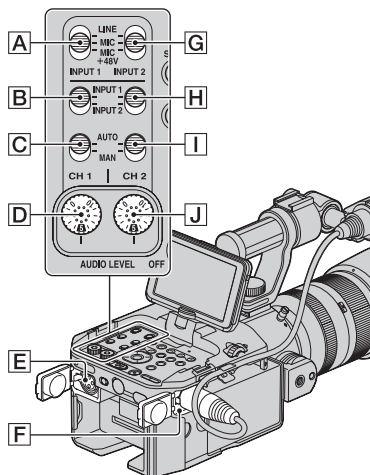

External audio jacks and switches

INPUT 1 jack **F**

INPUT 2 jack **E**

INPUT 1 switch **A**

INPUT 2 switch **G**

Audio source switches

CH1 (INPUT 1/INPUT 2) switch **B**

CH2 (INPUT 1/INPUT 2) switch **H**

Audio level controls

CH1 (AUTO/MAN) switch **C**

CH2 (AUTO/MAN) switch **I**

AUDIO LEVEL (CH1) dial **D**

AUDIO LEVEL (CH2) dial **J**

Recording sound via the supplied microphone

The sound will be recorded in monaural.

1 Attach the supplied microphone (p. 11) and connect it to the INPUT 1 jack [F].

2 Set the CH1 (INPUT 1/INPUT 2) [B] and CH2 (INPUT 1/INPUT 2) [H] switches to INPUT 1.

The same sound will be recorded on both CH1 and CH2.

3 Set the INPUT 1 switch [A] to MIC+48V.

Recording sound from an external audio device

To use an external audio device, or a microphone other than the supplied microphone, change the following settings.

1 Select the input source.

Set the INPUT 1/INPUT 2 switches according to the devices connected to the INPUT 1/INPUT 2 jacks.

Audio devices	Switch position
External audio device (mixer, etc.)	LINE
Dynamic microphones or microphones with a built-in battery	MIC
+48V powering (Phantom powering) microphone	MIC+48V

Notes







- If you connect a device that does not support +48V phantom power, malfunction may result from setting this switch to MIC+48V. Check before connecting the device.
- When there is no audio device connected to an INPUT jack, set the INPUT switch of that jack to LINE to prevent noise.

2 Set the input level of the microphone.

- Set the input level to the sensitivity of an XLR microphone you are using with [INPUT1 TRIM]/[INPUT2 TRIM] in the menu (p. 75). [0dB] will be appropriate for the supplied microphone (ECM-XM1).
- You can set an input level between -60 dBu (+12 dB) and -30 dBu (-18 dB) by 6 dB. The default setting is -48 dBu (0 dB).

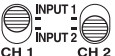
3 Select the channel you want to record.

Using the CH1/CH2 switches, select the source to be recorded on each channel.

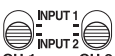
INPUT jack and recorded channel	Switch position
INPUT 1	 
INPUT 1 INPUT 2	 
INPUT 1 INPUT 2	 
INPUT 2	 

💡 Tips

- When you use a stereo microphone (2 XLR plugs), connect the L (left) channel plug to the INPUT 1 jack, and the R (right) channel plug to the INPUT 2 jack. Set the CH1 switch to INPUT 1, and the CH2 switch to INPUT 2.

Adjusting the volume

You can adjust the volume of the microphones connected to the INPUT 1/ INPUT 2 jacks.

1 Set the AUTO/MAN switch (C or I) of the channel to be adjusted to MAN.

♪M₂ appears on the screen.

2 Turn the AUDIO LEVEL dial (D or J) of the channel to be adjusted during recording or standby.

To restore automatic adjustment

Set the AUTO/MAN switch (G or I) of the manually adjusted channel to AUTO.

Setting the headphone sound

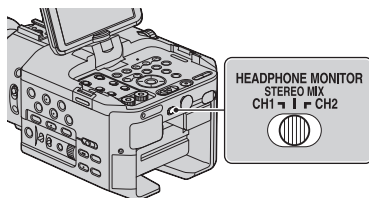

You can select the channel by setting the switch to CH1 or CH2, to output from the headphone.

See [HEADPHONE OUT] on the sound at STEREO MIX (p. 74).

Useful functions

Customizing the picture quality (Picture profile)

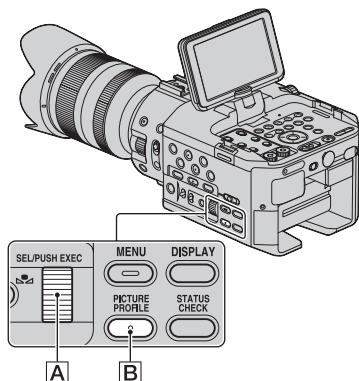

You can customize the picture quality by adjusting picture profile items such as [GAMMA] and [DETAIL].

Connect your camcorder to a TV or monitor, and adjust the picture quality while observing the picture on the TV or monitor screen.

Picture quality settings for different recording conditions have been stored in [PP1] through [PP6] as default settings.

Picture profile number	Recording condition
PP1	Default settings the same as when Picture Profile is [OFF]
PP2	Default settings the same as when Picture Profile is [OFF]
PP3	Example settings of natural color tone with ITU-709 gamma
PP4	Example settings of a color tone that is faithful to ITU-709
PP5	Example settings of pictures recorded on cinema color negative film
PP6	Example settings of pictures screened with cinema color print film

- 1** During standby, press the **PICTURE PROFILE** button **[B]**.
- 2** Select a picture profile number with the **SEL/PUSH EXEC** dial **[A]**.
You can record with the settings of the selected picture profile.
- 3** Select **[OK]** with the **SEL/PUSH EXEC** dial **[A]**.

To cancel the picture profile recording

Select [OFF] in step 2 with the SEL/PUSH EXEC dial **[A]**.

To change the picture profile

You can change the settings stored in [PP1] through [PP6].

- ① Press the PICTURE PROFILE button **[B]**.
- ② Select the PICTURE PROFILE number with the SEL/PUSH EXEC dial **[A]**.
- ③ Select [SETTING] with the SEL/PUSH EXEC dial **[A]**.
- ④ Select an item to be adjusted with the SEL/PUSH EXEC dial **[A]**.
- ⑤ Adjust the picture quality with the SEL/PUSH EXEC dial **[A]**.
- ⑥ Repeat steps ④ and ⑤ to adjust other items.
- ⑦ Select [← RETURN] with the SEL/PUSH EXEC dial **[A]**.
- ⑧ Select [OK] with the SEL/PUSH EXEC dial **[A]**.

A picture profile indicator appears.

Useful functions (Continued)

BLACK LEVEL

To set the black level.

Item	Description and settings
	Sets the black level. -15 to +15

GAMMA

To select a gamma curve.

Item	Description and settings
[STANDARD]	Standard gamma curve
[CINEMATONE1]	Gamma curve 1 for producing tone of film camera images
[CINEMATONE2]	Gamma curve 2 for producing tone of film camera images
[ITU709]	Gamma curve that corresponds to ITU-709. Gain in low intensity area: 4.5

BLACK GAMMA

To correct gamma in low intensity area.

Item	Description and settings
[RANGE]	Selects a correcting gamma. HIGH / MIDDLE / LOW
[LEVEL]	Sets the correcting level. -7 (maximum black compression) to +7 (maximum black stretch)

KNEE

To set knee point and slope for video signal compression to prevent over-exposure by limiting signals in high intensity areas of the subject to the dynamic range of your camcorder.

Item	Description and settings
[MODE]	Selects a mode either automatic or manual. [AUTO] : to set the knee point and slope automatically. [MANUAL] : to set the knee point and slope manually.
[AUTO SET]	Sets the maximum point and sensitivity in the automatic mode. [MAX POINT] : Sets the maximum point. 90% to 100% [SENSITIVITY] : Sets the sensitivity. HIGH / MIDDLE / LOW
[MANUAL SET]	Sets the knee point and slope manually. [POINT] : Sets the knee point. 75% to 105% [SLOPE] : Sets the knee slope. -5 (gentle) to +5 (steep)

COLOR MODE

To set type and level of colors.

Item	Description and settings
[TYPE]	Selects a type of colors. [STANDARD] : Standard colors [CINEMATONE1] : Film camera image-like colors good with [GAMMA] set to [CINEMATONE1] [CINEMATONE2] : Film camera image-like colors good with [GAMMA] set to [CINEMATONE2] [PRO] : Similar color tones to those of Sony professional cameras (when combined with ITU-709) [ITU709 MATRIX] : Colors corresponding to ITU-709
[LEVEL]	Sets a color level when you set [TYPE] to the settings other than [STANDARD]. 1 (close to color settings of [STANDARD]) to 8 (color settings of the selected type)

COLOR LEVEL

To set the color level.

Item	Description and settings
	-7 (light) to +7 (dark), -8: black and white

COLOR PHASE

To set the color phase.

Item	Description and settings
	-7 (greenish) to +7 (reddish)

COLOR DEPTH

To set the color depth for each color phase.

This function is more effective for chromatic colors and less effective for achromatic colors. The color looks deeper as you increase the setting value to more positive side, and lighter as you decrease the value to more negative side. This function is effective even if you set [COLOR LEVEL] to [-8] (black and white).

Item	Description and settings
[R]	-7 (light red) to +7 (deep red)
[G]	-7 (light green) to +7 (deep green)
[B]	-7 (light blue) to +7 (deep blue)
[C]	-7 (light cyan) to +7 (deep cyan)
[M]	-7 (light magenta) to +7 (deep magenta)
[Y]	-7 (light yellow) to +7 (deep yellow)

Useful functions (Continued)

WB SHIFT

To set items for the white balance shift.

Item	Description and settings
[FILTER TYPE]	Selects a color filter type for the white balance shift. [LB-CC] : Film type (color conversion and correction) [R-B] : Video type (correction of R and B levels)
[LB{COLOR TEMP}]	Sets a color temperature offset value. -9 (bluish) to +9 (reddish)
[CC{MG/GR}]	Sets a color correct offset value. -9 (greenish) to +9 (magentish)
[R GAIN]	Sets an R level. -9 (low R level) to +9 (high R level)
[B GAIN]	Sets a B level. -9 (low B level) to +9 (high B level)

DETAIL

To set items for the detail.

Item	Description and settings
[LEVEL]	Sets the detail level. -7 to +7
[MANUAL SET]	[ON/OFF] : Turns on and off the manual detail adjustment. [ON] : Enables the manual detail adjustment (automatic optimization will not be performed). [OFF] : Disables the manual detail adjustment.
[V/H BALANCE]	: Sets the vertical (V) and horizontal (H) balance of DETAIL. -2 (off to the vertical (V) side) to +2 (off to the horizontal (H) side)
[B/W BALANCE]	: Selects the balance of the lower DETAIL (B) and the upper DETAIL (W). TYPE1 (off to the lower DETAIL (B) side) to TYPE5 (off to the upper DETAIL (W) side)
[LIMIT]	: Sets the limit level of DETAIL. 0 (Low limit level: likely to be limited) to 7 (High limit level: not likely to be limited)
[CRISPENING]	: Sets the crispening level. 0 (shallow crispening level) to 7 (deep crispening level)
[HI-LIGHT DETAIL]:	Sets the DETAIL level in the high intensity areas. 0 to 4

COPY

To copy the settings of the picture profile to another picture profile number.

RESET

To reset the picture profile to the default setting.

To copy the picture profile setting to another picture profile number

See page 38 for the location of the buttons.

- ① Press the PICTURE PROFILE button **[B]**.
- ② Select the picture profile number that you want to copy from with the SEL/PUSH EXEC dial **[A]**.
- ③ Select [SETTING] → [COPY] with SEL/PUSH EXEC dial **[A]**.
- ④ Select the number of the picture profile that you want to copy to with the SEL/PUSH EXEC dial **[A]**.
- ⑤ Select [YES] with the SEL/PUSH EXEC dial **[A]**.
- ⑥ Select [↩ RETURN] → [OK] with the SEL/PUSH EXEC dial **[A]**.

To reset the picture profile settings

You can reset the picture profile settings by each picture profile number. You cannot reset all picture profile settings at once. See page 38 for the location of the buttons.

- ① Press the PICTURE PROFILE button **[B]**.
- ② Select the number of the picture profile that you want to reset with the SEL/PUSH EXEC dial **[A]**.
- ③ Select [SETTING] → [RESET] → [YES] → [↩ RETURN] → [OK] with the SEL/PUSH EXEC dial **[A]**.

Acquiring location information (GPS)



- 1 Press the MENU button during standby.

- 2 Select  (OTHERS) → [GPS SETTING] → [ON] (default setting) with the SEL/PUSH EXEC dial.



 appears, and your camcorder starts trying to triangulate. When your camcorder triangulates successfully, it will record the location information at the time movies were recorded.

Notes

- The indicator changes according to the strength of GPS signal reception.

Triangulating status	GPS indicators	GPS reception status
Function off	No indicator	[GPS SETTING] is set to [OFF], or the GPS receiver is not functioning normally.
Difficult	NO GPS SIGNAL	The camcorder cannot find a GPS signal, therefore, it cannot triangulate. Use the camcorder in an open area.
Searching		The camcorder is searching the GPS signal. It may take several minutes until the camcorder triangulates.
Triangulating		The camcorder is receiving a weak GPS signal.

Useful functions (Continued)

Tri-angulating status	GPS indicators	GPS reception status
Tri-angulating		The camcorder is receiving a GPS signal, and can acquire location information.
Tri-angulating		The camcorder is receiving a strong GPS signal, and can acquire location information.

- [GPS SETTING] is set to [ON] in the default setting. Movies recorded during triangulation by GPS will be recorded with location information. If you do not want to record location information, set [GPS SETTING] to [OFF].
- If the GPS indicator does not become a triangulating status indicator even after several minutes, the camcorder is having trouble with receiving GPS signals. You may start recording if you do not need to record location information, or go to a location with access to the open sky.
- The camcorder can hardly receive GPS signals indoors or near tall buildings. Go to a location with access to the open sky.
- Even if a triangulating status indicator is displayed, the camcorder may not record the GPS information continuously, depending on the condition of GPS signal reception.

Setting time data

The camcorder records movies accompanied by time data, such as time code and user bit.

Display the setting screen by pressing the MENU button → select **00:00** (TC/UB SET) with the SEL/PUSH EXEC dial.

Presetting the time code

- ① Select [TC PRESET] with the SEL/PUSH EXEC dial.
- ② Select [PRESET] with the SEL/PUSH EXEC dial.

- ③ Select the first 2 digits with the SEL/PUSH EXEC dial.
You can set the time code between 00:00:00:00 and 23:59:59:24.
- ④ Set other digits by repeating step ③.
- ⑤ Select [OK] with the SEL/PUSH EXEC dial.

To reset the time code

You can reset the time code (00:00:00:00). Select [RESET] in step ② of “Presetting the time code.”

To reset the time code using the Wireless Remote Commander

You can reset the time code (00:00:00:00) also by pressing the TC RESET button on the Wireless Remote Commander.

Presetting the user bit

- ① Select [UB PRESET] with the SEL/PUSH EXEC dial.
- ② Select [PRESET] with the SEL/PUSH EXEC dial.
- ③ Select the first 2 digits with the SEL/PUSH EXEC dial.
- ④ Set other digits by repeating step ③.
- ⑤ Select [OK] with the SEL/PUSH EXEC dial.

To reset the user bit

You can reset the user bit (00 00 00 00). Select [RESET] in step ② of “Presetting the user bit.”

Recording with the SMOOTH SLOW REC function

Fast moving subjects and actions, which cannot be captured under the general recording conditions, can be recorded in smooth moving slow-motion (25% slow). This is useful for recording fast actions such as a golf or tennis swing.

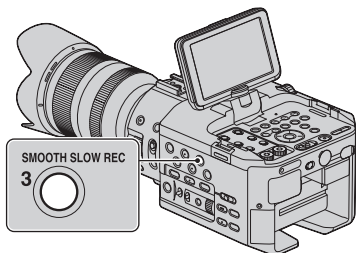

Press the SMOOTH SLOW REC button, then the START/STOP button.

A recording of about 3 seconds is stretched to about 12 seconds and recorded as a slow-motion movie.

Recording ends when [Recording...] disappears from the screen.

To cancel SMOOTH SLOW REC

Press the SMOOTH SLOW REC button or the MENU button.

To change the timing

You can select when recording starts in relation to when the SMOOTH SLOW REC button is pressed.

Press MENU → select (CAMERA SET) menu → [SMOOTH SLOW REC] → [REC TIMING] → a desired setting with the SEL/PUSH EXEC dial.

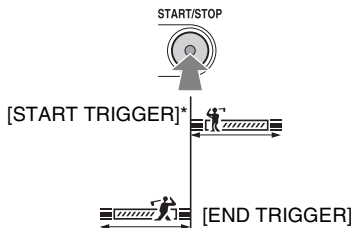

* The default setting is [START TRIGGER].

Notes

- Sounds cannot be recorded.
- The image quality is lower than with the regular recording.
- You cannot set a slower shutter speed than 1/215 second.
- The simultaneous recording on the memory card and the flash memory unit is not available.
- The time of the movie recorded using SMOOTH SLOW REC is recorded after being converted to slow-motion, not the time when the movie is actually shot.
- SMOOTH SLOW REC is not available with standard definition image quality (SD).
- With SMOOTH SLOW REC, the angle of view will be narrower by 25%.

Tips

- During SMOOTH SLOW REC, the high definition image quality (HD) recording format changes to [1080/50i FH]. When you finish SMOOTH SLOW REC, the normal recording setting is restored.
- Movies are recorded on the medium selected with [] REC MEDIA SETTING[.

Useful functions (Continued)

Recording with the Slow & Quick Motion function

By recording with a frame rate that is different from the playback frame rate, you can record images to be played back as slow motion or quick motion images. The images recorded with the Slow & Quick Motion function will appear smoother than slow or fast-forward playback of images recorded at normal speed.

You can use the Slow & Quick Motion function with high definition image quality (HD) only.

Playback speed

The playback speeds based on the recording format and frame rate setting are as follows.

FRAME RATE	REC FORMAT	
	1080/25p	1080/50p
50	50% slow	100% (standard)
25	100% (standard)	200% quick
12	208% quick	417% quick
6	417% quick	833% quick
3	833% quick	1667% quick
2	1250% quick	2500% quick
1	2500% quick	5000% quick

START/STOP button

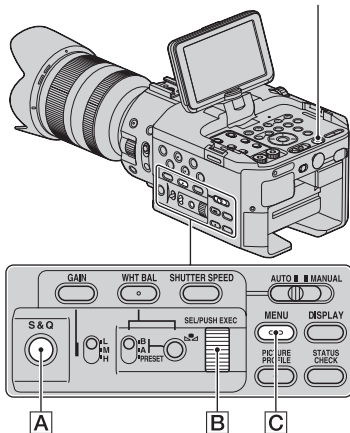



Notes

- You must use “Memory Stick PRO-HG Duo” media or SD card Class 10 or faster for Slow & Quick Motion recording.
- When recording with the Quick Motion recording function, your camcorder may continue recording for some time (approximately 30 seconds at most) after you press the button to stop recording. Do not operate your camcorder while the [REC] indicator is flashing on the screen, but wait till it turns to [STBY].
- After you press the button to stop recording, your camcorder continues recording till it completes writing of the minimum unit of data (0.5 seconds of replay time).

Preparation

You must set the recording format and frame rate.

- ① Press the MENU button **[C]**.
- ② Select  (CAMERA SET) → [S&Q MOTION] → [REC FORMAT] with the SEL/PUSH EXEC dial **[B]**.
- ③ Select a recording format.
You can select one from 1080/50p PS, 1080/25p FX, or 1080/25p FH.
- ④ Select [FRAME RATE] with the SEL/PUSH EXEC dial **[B]**, and set a desired frame rate.
You can select one from 50 fps, 25 fps, 12 fps, 6 fps, 3 fps, 2 fps, or 1 fps.
- ⑤ Select [ RETURN] → **[X]**.

To record with the Slow & Quick Motion function

Press the S&Q button **[A]**, then the START/STOP button.

Recording starts.

To stop Slow & Quick Motion recording

Press the START/STOP button again.

To change the frame rate setting

Hold the S&Q button **[A]** down for about 1 second, then change the value with the SEL/PUSH EXEC dial.

Holding the S&Q button **[A]** down again for about 1 second restores the previous setting.

To cancel Slow & Quick Motion recording

Press the S&Q button **[A]** or the MENU button **[C]** during standby.

Notes

- When you are recording with a slow frame rate, the camcorder may continue recording for a few more seconds after you press the START/STOP button to stop recording.
- You cannot change the frame rate during Slow & Quick Motion recording. To change the frame rate, stop current Slow & Quick Motion recording.
- The time code is recorded in the [REC RUN] mode during Slow & Quick Motion recording (p. 79).
- The Slow & Quick Motion mode is canceled automatically when the POWER switch is set to OFF, but the frame rate setting is retained.
- You can record sound only at 100% (standard).
- You cannot use the Slow & Quick Motion function for the simultaneous recording.
- You cannot use the Slow & Quick Motion function with the standard image quality (SD).

Reviewing the most recently recorded scene (Last Scene Review)

You can review the most recently recorded scene on the screen.

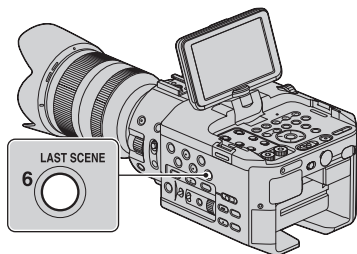

Right after you stop recording, press the **LAST SCENE** button.

The camcorder plays from the top to the end of the most recently recorded scene, then returns to standby mode.

To stop reviewing the last scene

Press the **LAST SCENE** button during playback. The camcorder returns to standby mode.

Notes

- If you edit the movie or remove the recording media after you stop recording, the Last Scene Review function may not work correctly.
- You cannot use the Last Scene Review function with **SMOOTH SLOW REC**.

Assigning the functions to the **ASSIGN** buttons

Some functions can be assigned to the **ASSIGN** buttons for use. You can assign a single function to any one of the **ASSIGN 1** to **6** buttons.

See “Menu items” (p. 68) on the function of each item.

Default function of each **ASSIGN** button

- **ASSIGN 1**: ZEBRA (p. 76)
- **ASSIGN 2**: HISTOGRAM (p. 76)
- **ASSIGN 3**: SMOOTH SLOW REC (p. 45)
- **ASSIGN 4**: PEAKING (p. 76)
- **ASSIGN 5**: MARKER (p. 77)
- **ASSIGN 6**: LAST SCENE (p. 48)

Functions you can assign to the **ASSIGN** buttons

- - (no function)
- **LAST SCENE REVIEW** (p. 48)
- **WB PRESET** (p. 33)
- **AE SHIFT** (p. 71)
- **STEADYSHOT** (p. 72)
- **SMOOTH SLOW REC** (p. 45)
- **COLOR BAR** (p. 72)
- **HISTOGRAM** (p. 76)
- **ZEBRA** (p. 76)
- **PEAKING** (p. 76)
- **MARKER** (p. 77)
- **CAMERA DATA DISPLAY** (p. 77)
- **AUDIO LEVEL DISPLAY** (p. 78)
- **REC LAMP[F]** (p. 82)
- **REC LAMP[R]** (p. 82)
- **VISUAL INDEX** (p. 50)

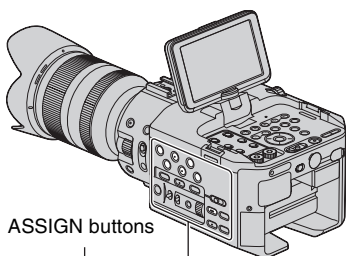

ASSIGN buttons

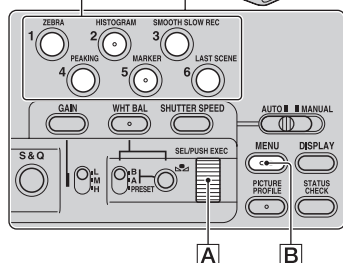

- 1 Press the MENU button **[B]**.
- 2 Select **[OTHERS]** → **[ASSIGN BUTTON]** with the SEL/PUSH EXEC dial **[A]**.

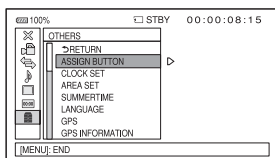

- 3 Select the **ASSIGN** button to which you want to assign a function with the SEL/PUSH EXEC dial **[A]**.
 - [-----] appears if no function is assigned to the ASSIGN button.

4 Select the function that you want to assign with the SEL/PUSH EXEC dial **[A]**.

5 Select **[OK]** with the SEL/PUSH EXEC dial **[A]**.

6 Select **[↵ RETURN]** with the SEL/PUSH EXEC dial **[A]**.

7 Press the MENU button **[B]** to hide the menu screen.

Playback

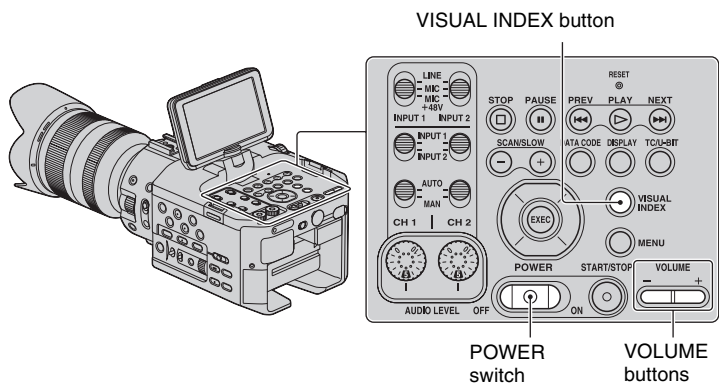

You can play back movies as follows:

1 Slide the POWER switch to ON.

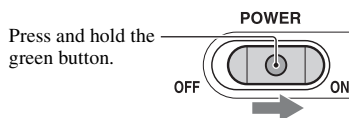

2 Press the VISUAL INDEX button.

The VISUAL INDEX screen appears after a few seconds.

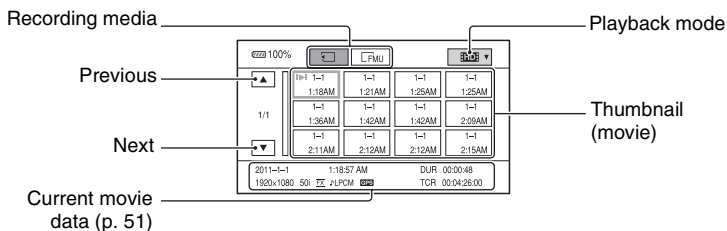

- You can turn on or off the time and date display on the thumbnails by pressing the DISPLAY button.

3 Play back movies.

- Touch the recording media you want to play back.
 : Memory card
 FMU : Flash memory unit
- Touch the playback mode, and select the desired image quality of movies.

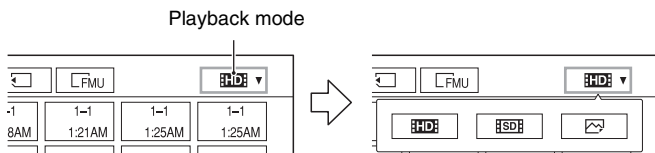

HDD : High definition image quality (HD)

HSD : Standard definition image quality (SD)

- Touch twice the thumbnail of the movie you want to play back.
 You can also select the movie to be played back by pressing $\leftarrow/\rightarrow/\uparrow/\downarrow$ buttons followed by pressing the EXEC button.
 The first touch will show the information on the movie at the lower part of the screen.

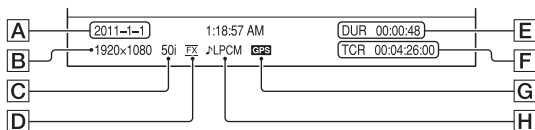

A Date and time of recording started

B Resolution

C Frame rate

D Record mode

E Duration

F Time code of recording started

Time code will not be displayed correctly when you play back recording media with no time code, or recording media with time code that your camcorder does not support.

G GPS data

Appears on the movie that was recorded with [GPS SETTING] set to [ON] (default setting) on the [OTHERS] menu.

H LPCM recording

Appears when audio is recorded in Linear PCM. This does not appear for movies in the standard definition image quality (SD).

- \blacktriangleright appears with the movie that has been most recently played back or recorded. If you touch the movie with \blacktriangleright , you can continue playback from the previous time.

Playback (Continued)

Your camcorder starts playing the selected movie.

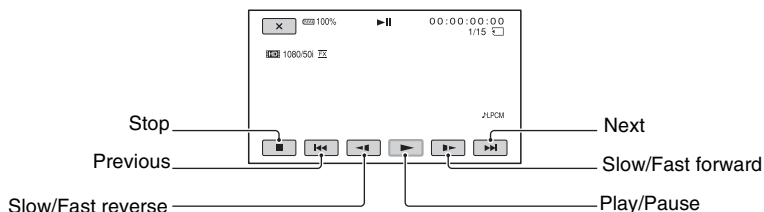

Notes

- You may not be able to play back movies recorded on other camcorders.
- If you touch the thumbnail and press the PLAY button, the most recently recorded or played scene is played back.

Tips

- When playback from the selected movie reaches the last movie, the screen returns to the VISUAL INDEX screen.
- Touch **◀|▶** during pause to play back movies slowly.
- As you repeat touching **⏮** / **⏭** during playback, movies are played back as fast as about 5 times → about 10 times → about 30 times → about 60 times.
- Reduced-size images which enable you to view many movies at the same time on the VISUAL INDEX screen are called “thumbnails.”
- You can operate playback using the PREV/PLAY/NEXT/STOP/PAUSE/SCAN/SLOW buttons on the camcorder.

To adjust the volume

Adjust the volume with the VOLUME buttons.

To return to the recording mode

Press the VISUAL INDEX button.

Viewing still images

You can create still images by capturing scenes from movies that you recorded on your camcorder (p. 59).

View still images.

- ① Touch the recording media you want to view.
 - ☑ : Memory card
 - ☑ FMU: Flash memory unit

- ② Touch the playback mode, then select  (still image).

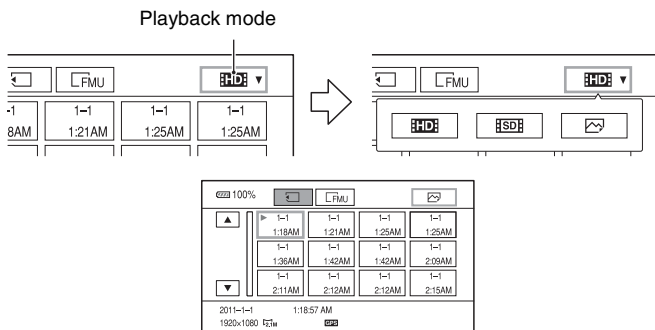

- ③ Touch twice the thumbnail of the still image you want to view.
The first touch will show the information on the still image at the lower part of the screen.

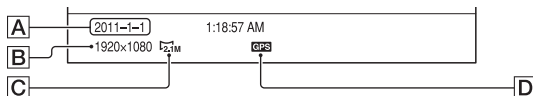

- A** Date and time of recording
- B** Resolution
- C** Image size
- D** GPS data

Appears on a still image that was created from a movie recorded with [GPS SETTING] set to [ON] (default setting) on the [OTHERS] menu.

Your camcorder displays the selected still image.

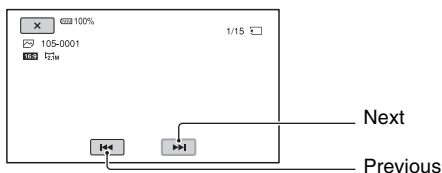

Changing/checking the settings in your camcorder

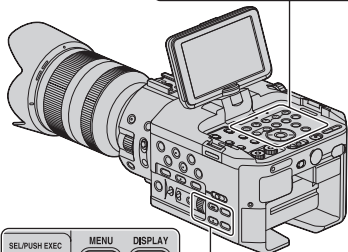
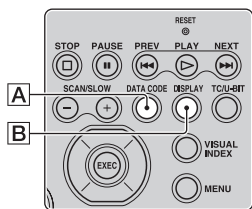

Changing the screen

You can turn on and off the display of the time code, and other information on the screen.

Press the DISPLAY button [B].

The screen indicators turn on (displayed) and off (not displayed) as you press the button.

In the recording mode, the screen changes like “detailed display → simple display → no display” as you press the button.

Tips

- You can display the screen indicators during playback on a TV. Select [ALL OUTPUT] of [DISPLAY OUTPUT] (p. 78).

Displaying recording data (Data code)

You can display information, including date, time, camera data and GPS triangulation data automatically stored during recording on the screen during playback.

Press the DATA CODE button [A] during playback or pause.

The screen changes like “date and time display → camera data display → GPS triangulation data → no display” as you press the button.

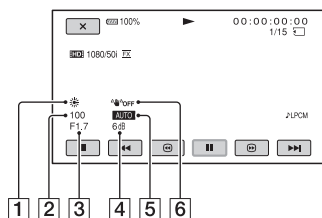

- 1 White balance
[PWB] appears during playback of the movie recorded with [MANU WB TEMP].
- 2 Shutter speed
- 3 Iris
- 4 Gain
- 5 Exposure
[AUTO] appears during playback of the movie recorded with the iris, gain or shutter speed automatically adjusted.
[MANUAL] appears during playback of the movie recorded with the iris, gain or shutter speed manually adjusted.
- 6 SteadyShot

Notes

- The exposure correction value (EV), shutter speed, iris and flash on/off will be displayed during viewing still images.
- When you play back the memory card on other devices, the camera data may be displayed incorrectly. Confirm the correct camera data on your camcorder.
- When GPS triangulation data is displayed, latitude and longitude are displayed in the data code area.
- If you record without receiving GPS data, bars such as [--- ----] will be displayed.

Displaying the settings in your camcorder (Status check)

You can check the settings of the following items.

- Audio setup such as microphone volume level (p. 74)
- Output signal setup ([VIDEO OUT], etc.) (p. 73)
- Functions assigned to the ASSIGN buttons (p. 48)
- Camera setup (p. 71)
- Recording media information
You can check the estimated used and free spaces.

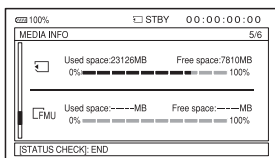

Battery Info

You can check the remaining capacity of the attached battery.

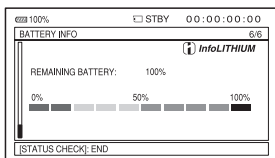

1 Press the STATUS CHECK button .

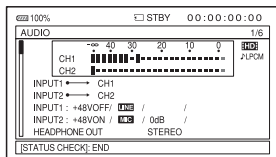

2 Turn the SEL/PUSH EXEC dial until a desired display shows up on the screen.

AUDIO → OUTPUT → ASSIGN →
CAMERA → MEDIA INFO →
BATTERY INFO

Setup items are displayed according to the settings of the camcorder when it is turned on.

To hide the display

Press the STATUS CHECK button .

Connecting a monitor or a TV

Playback image quality depends on the type of monitor or TV, or the jacks used to make the connection.

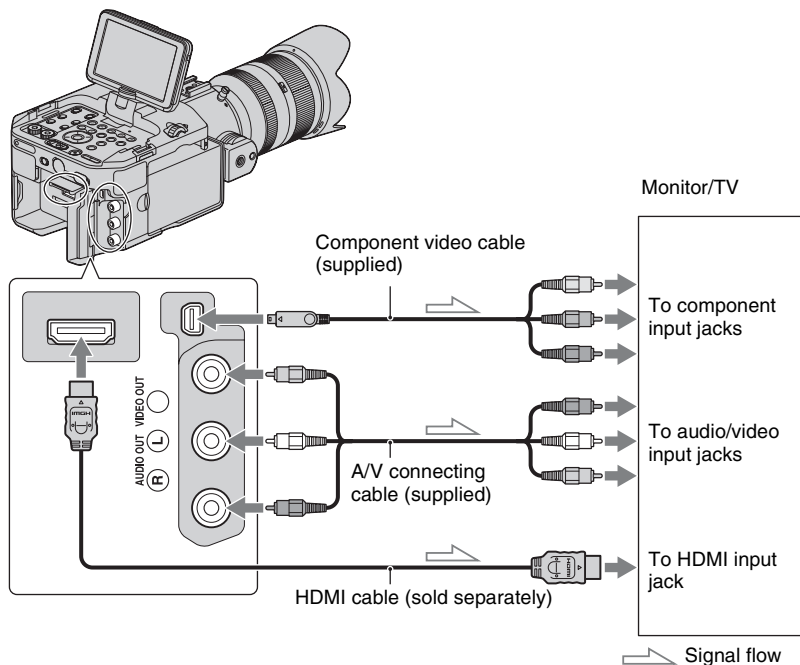

Signals are output from the HDMI OUT and COMPONENT OUT jacks simultaneously. In the case of the A/V connecting cable connection, signals are output from the VIDEO OUT jack.

Notes

- Output resolution depends on the settings of [HDMI/COMPONENT].

HD/SD	[HDMI/COMPONENT] setting	Output resolution		
		HDMI OUT	COMPONENT OUT	VIDEO OUT
HD	1080p/576i	1080p	1080p	576i
	720p/576i	720p	720p	576i
	1080i/576i	1080i	1080i	576i
	576p	576p	576p	576i
	576i	576i	576i	576i
	1080p/576i	576i	576i	576i
SD	720p/576i	576i	576i	576i
	1080i/576i	576i	576i	576i
	576p	576p	576p	576i
	576i	576i	576i	576i
	576i	576i	576i	576i

- Use an HDMI cable with the HDMI logo.
- Images are not output from the HDMI OUT jack of your camcorder, if copyright protection signals are recorded in the movies.
- Images and sounds may not be reproduced correctly on some monitors or TVs.
- Do not connect the output jacks of the camcorder with the output jacks of the monitor or TV. A malfunction may be caused.
- When 25p of frame rate is selected in [HDMI] REC FORMAT], progressive signals are converted to interlace signals by the pull-down system to be output.
- During recording with [HDMI] REC FORMAT] set to [1080/50p PS], the camcorder does not output 720p or 576p signals. Therefore, if [HDMI/COMPONENT] is set to [720p/576i] or [576p], the screen of the connected device becomes blank, until you change the setting.
- If you display the edit screen while outputting signals to a TV or monitor, the menu may not be displayed correctly.
- This camcorder is not compatible with "BRAVIA" sync.

Tips

- HDMI (High-Definition Multimedia Interface) is an interface to send both video/audio signals. The HDMI OUT jack outputs high quality images and digital audio.

If your TV/VCR has a 21-pin adaptor (EUROCONNECTOR)

Use a 21-pin adaptor (commercially available) to view playback images.

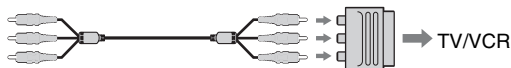

Protecting recorded images (Protect)

Protect movies and still images to avoid deleting them by mistake.

1 Press the MENU button when the VISUAL INDEX screen is displayed.

2 Select  (EDIT) → [PROTECT] with the SEL/PUSH EXEC dial.

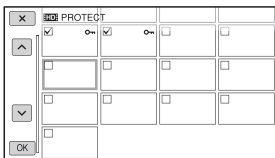

3 Touch the movies or still images to be protected.

✓ is displayed on the selected images.



Tips

- Press and hold the image down to preview the image. Touch  to return to the previous screen.
- You can select up to 100 images at one time.

4 Touch  →  → .

To undo the protection of movies and still images

Touch the movie or still image marked with

- ✓ in step 3.
- ✓ disappears.

Capturing still images from a movie

You can save a selected frame from a recorded movie as a still image.

1 Press the **MENU** button while playing back movies.

2 Select  (**EDIT**) → [**PHOTO CAPTURE**] with the **SEL/PUSH EXEC** dial.

3 Touch **II** at the point where you want to capture.

After you select the point with **II**, make fine adjustment with these buttons.

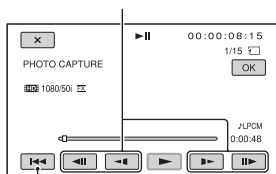

Returns to the beginning of the selected movie.

4 Touch **OK**.

The captured still image is saved on the same recording media as that of the playing movie. When capturing is finished, the screen returns to pause.

Notes

- The image size is fixed depending on the image quality of the movie:
 - [2.1M] with high definition image quality (HD)
 - [0.2M] in 16:9 (wide) with standard definition image quality (SD)
 - [VGA(0.3M)] in 4:3 with standard definition image quality (SD)

- The recording media where you want to save still images should have enough free space.
- The recording date and time of captured still images is the same as the recording date and time of the movies.
- If the movie you are capturing from has no data code, the recording date and time of the still image will be the date and time you captured from the movie.

Dividing a movie

You can divide a movie at a designated point.

1 Press the **MENU** button while playing back movies.

2 Select  (**EDIT**) → [**DIVIDE**] with the **SEL/PUSH EXEC** dial.

3 Touch **II** at the point where you want to divide.

After you select the point with **II**, make fine adjustment with these buttons.

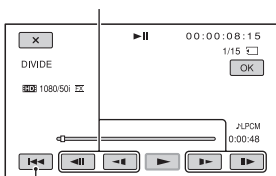

Returns to the beginning of the selected movie.

4 Touch .

Notes

- You cannot restore movies once they are divided.
- Do not remove the battery pack, the AC Adaptor/Charger or the recording media that contains the movies from your camcorder during the operation. It may damage the recording media.
- A slight difference may occur from the point where you touch **II** and the actual dividing point, as your camcorder selects the dividing point based in about half-second increments.

Tips

- Only simple editing is available on this camcorder. Use commercially available editing software for more advanced editing.

Deleting movies and still images

You can free media space by deleting movies and still images from recording media.

Notes

- You cannot restore images once they are deleted.
- Do not remove the battery pack, the AC Adaptor/Charger or the recording media that contains the movies or still images from your camcorder during the operation. It may damage the recording media.
- You cannot delete protected movies and still images. Undo the protection of the movies and still images, before you try to delete them (p. 58).
- Save important movies and still images in advance (p. 87).

Tips

- You can select up to 100 images at one time.
- To delete all data recorded on the recording media and recover all the recordable space of the media, format the media (p. 63).

Tips

- Press and hold the image down to preview the image. Touch to return to the previous screen.
-  appears at the upper right corner on the thumbnail of protected images.
- No check box appears on the thumbnail of protected images.

4 Touch → → .

1 Press the MENU button when the VISUAL INDEX screen is displayed.

2 Select  (EDIT) → [DELETE] with the SEL/PUSH EXEC dial.

3 Touch the movies or still images to be deleted.

- ✓ is displayed on the selected images.

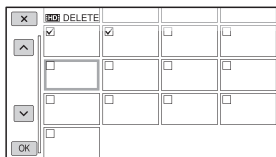

Copying movies/still images

You can copy movies and still images between following recording media:
Memory card → Flash memory unit
Memory card → External media device
Flash memory unit → Memory card
Flash memory unit → External media device
Get the recording media ready before the operation.

Notes

- If there is no image database file on the flash memory unit, you cannot copy movies. In this case, press the MENU button, then select [OTHERS] → [REPAIR IMAGE DB FILE] → [FMU], to create the image database file.
- Connect your camcorder to the wall outlet (wall socket) using the supplied AC Adaptor/Charger to prevent your camcorder from running out of power during the operation.

Tips

- The original movie will not be deleted after copying.

1 Press the MENU button when the VISUAL INDEX screen is displayed.

2 Select  (EDIT) → [COPY] with the SEL/PUSH EXEC dial.

3 Select the recording media to copy from and to.

4 Select [Multiple Images].

5 Select the image type ([HDD MOVIE], [HSD MOVIE], [PHOTO]).

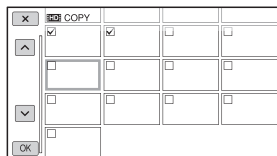

6 Touch the movies or still images to be copied.

- ✓ is displayed on the selected image. You can select multiple images.



Tips

- Press and hold the image down to preview the image. Touch  to return to the previous screen.

7 Touch  →  → .

To copy all movies or still images

Select [All] in step 4, and the image type in step 5.

Formatting the recording media

Formatting deletes all data from the recording media to recover recordable free space.

🔗 Notes

- Connect your camcorder to the wall outlet (wall socket) using the supplied AC Adaptor/Charger to prevent your camcorder from running out of power during the operation.
- To avoid the loss of important images, you should save them (p. 87) before formatting the recording media.
- Protected movies and still images are also deleted.

1 Press the MENU button.

2 Select  (OTHERS) → [MEDIA FORMAT] with the SEL/PUSH EXEC dial.

3 Select the recording media to be formatted.

4 Touch  → .

🔗 Notes

- While [Executing...] is displayed, do not operate the buttons on the camcorder, disconnect the AC Adaptor/Charger, or remove the recording media from your camcorder. (The access lamp is lit or flashing while formatting recording media.)

Preventing data on recording media from being recovered

Unintelligible data will be written on recording media. Thus, it may become more difficult to recover any original data. Even if you format recording media, there may be some data remaining. Therefore, when you dispose of or transfer the recording media, it is recommended that you perform the [Empty] operation.

ⓘ Notes

- If you perform this operation, all stored data are deleted. To avoid the loss of important images, you should save them (p. 87) before the operation.
- You cannot perform this operation unless you connect the AC Adaptor/Charger to the wall outlet (wall socket).
- Disconnect all cables except the AC Adaptor/Charger. Do not disconnect the AC Adaptor/Charger during the operation.
- Do not apply any vibrations or shocks to your camcorder during this operation.

1 Operate the camcorder on an outside power source using the AC Adaptor/Charger (p. 17).

2 Set the POWER switch to ON.

3 Press the MENU button.

4 Select  (OTHERS) → [MEDIA FORMAT] with the SEL/PUSH EXEC dial.

5 Select the recording media to be formatted.

The format screen appears.

6 Touch [Empty] → .

ⓘ Notes

- It may take from several minutes to several hours to empty recording media, depending on the capacity. You can check the actual time required on the LCD screen.
- If you stop the operation while [Executing...] is displayed, be sure to complete the operation by performing [MEDIA FORMAT] or emptying when you use the recording media next time.

Repairing the image database file

This function checks the database information and the consistency of movies and still images on the recording media, and repairs if any inconsistencies found.

🔌 Notes

- Connect your camcorder to the wall outlet (wall socket) using the supplied AC Adaptor/Charger to prevent your camcorder from running out of power during the operation.

1 Press the MENU button.

2 Select  (OTHERS) → [REPAIR IMAGE DB FILE] with the SEL/PUSH EXEC dial.

3 Select the recording media you want to check the database file.

4 Touch .

The database file check starts. Touch  and quit the database file check if no inconsistency is found.

5 Touch .

After [Completed.] appears, touch .

🔌 Notes

- If you stop the operation while [Repairing the image database file.] is displayed, be sure to complete the operation as described above when you use the recording media next time.

Operating the menu

You can change various settings or make detailed adjustments using the menu items displayed on the screen.

POWER switch

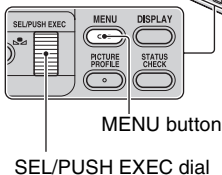
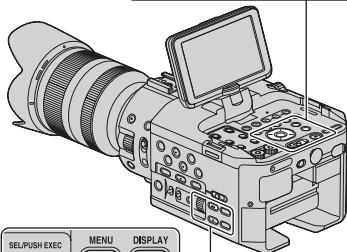
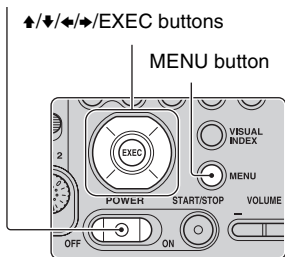

SEL/PUSH EXEC dial

1 Set the POWER switch to ON.

2 Press the MENU button.

The menu screen appears.

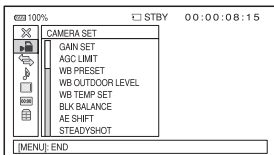

3 Turn the SEL/PUSH EXEC dial until the icon of the desired menu is highlighted, then press the dial to select the menu.

- CAMERA SET (p. 71)
- REC/OUT SET (p. 73)
- AUDIO SET (p. 74)
- DISPLAY SET (p. 76)
- TC/UB SET (p. 79)
- OTHERS (p. 80)
- EDIT (p. 70)

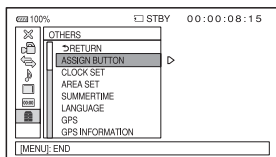

4 Turn the SEL/PUSH EXEC dial until the desired menu item is highlighted, then press the dial to select the item.

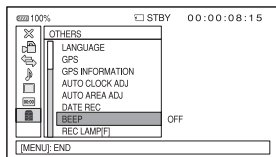

-
- 5** Turn the SEL/PUSH EXEC dial until the desired setting is highlighted, then press the dial to confirm the setting.

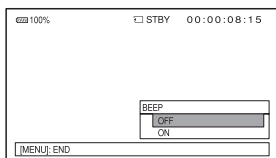

-
- 6** Press the MENU button to hide the menu screen.

To return to the previous screen, select [↵ RETURN].

⚡ Notes

- The available menu items vary depending on the context of your camcorder during recording or playback.

Menu items

●: Functions that return to the default settings when you switch the format, perform the functions by the MENU button, or turn off the camcorder.

ASSIGN: Functions that can be assigned to the ASSIGN buttons.



(CAMERA SET) menu (p. 71)

GAIN SET	Sets gain values for H, M and L positions of the GAIN switch.	
AGC LIMIT	Selects the upper limit for the Auto Gain Control (AGC).	
WB PRESET	Selects the preset white balance.	ASSIGN
WB OUTDOOR LEVEL	Sets an offset value to adjust the outdoor white balance	
WB TEMP SET	Set the color temperature for [MANU WB TEMP].	
BLACK BALANCE	Adjusts the black balance.	
AE SHIFT	Sets the AE shift.	ASSIGN
STEADYSHOT	Activates the camera-shake reduction.	ASSIGN
SMOOTH SLOW REC	Records smooth slow motion movies.	ASSIGN
S&Q MOTION	Records movies to be played back as either slow motion or quick motion.	
COLOR BAR	Turns on or off the color bars and tone.	● ASSIGN



(REC/OUT SET) menu (p. 73)

REC SET	Sets the image quality and aspect ratio for recording.	
VIDEO OUT	Sets output signals.	



(AUDIO SET) menu (p. 74)

AUDIO FORMAT	Sets the audio format for high definition image quality (HD) recording.	
AUDIO LIMIT	Sets the clipping-noise reduction function.	
HEADPHONE OUT	Sets the sound to output to the headphone.	
XLR SET	Sets the XLR input (microphone/line).	



(DISPLAY SET) menu (p. 76)

HISTOGRAM	Displays the histogram.	ASSIGN
ZEBRA	Displays a zebra pattern as a guide for adjusting brightness.	ASSIGN
PEAKING	Displays an image with its outlines enhanced.	ASSIGN
MARKER	Displays markers to check the composition.	ASSIGN
CAMERA DATA DISPLAY	Constantly displays the iris, gain and shutter speed settings.	ASSIGN
AUDIO LEVEL DISPLAY	Displays the audio level meter.	ASSIGN
ZOOM DISPLAY	Selects the zoom position display.	
LCD BRIGHT	Adjusts the brightness of the LCD screen.	

DISPLAY OUTPUT Selects where to output the display information.

00:00 (TC/UB SET) menu (p. 79)

TC PRESET	Sets the time code.
UB PRESET	Sets the user bits.
TC RUN	Selects how the time code advances.
TC MAKE	Selects how the time code is recorded on the recording media.
UB TIME REC	Saves the actual time in the user bits.

(OTHERS) menu (p. 80)

ASSIGN BUTTON	Assigns functions to the ASSIGN buttons.
CLOCK SET	Sets the date and time.
AREA SET	Sets the area you use the camcorder.
SUMMERTIME	Set the summertime.
LANGUAGE	Sets the language of the on-screen display.
GPS SETTING	Sets the GPS.
GPS INFORMATION	Displays the triangulating information.
AUTO CLOCK ADJ	Maintains accurate time automatically by acquiring time information from the GPS system.
AUTO AREA ADJ	Compensates for time differences automatically by acquiring location information from the GPS system.
DATE REC	Superimposes the date and time on images.
BEEP	Sounds the operation melody.
REC LAMP[F]	Turns off the front recording lamp. [ASSIGN]
REC LAMP[R]	Turns off the rear recording lamp. [ASSIGN]
REMOTE CONTROL	Disables the supplied Wireless Remote Commander.
MEDIA FORMAT	Formats the recording media.
REPAIR IMAGE DB FILE	Checks the database information and the consistency of movies and still images on the recording media, and repairs if any inconsistencies found.
USB CONNECT	Used when [USB CONNECT] does not appear on the screen by connecting the camcorder to another device with the USB cable.
OPERATION TIME	Displays the total hours of operation.
CALIBRATION	Calibrates the touch panel.

Menu items (Continued)



(EDIT) menu (p. 58, 59, 60, 61, 62)

PROTECT	Protects movies and still images to avoid deleting them by mistake.
DIVIDE	Divides movies.
DELETE	Deletes images.
PHOTO CAPTURE	Captures still images from movies.
COPY	Copies movies or still images from a memory card to a flash memory unit.

Tips

- You can display the [EDIT] menu by pressing the MENU button when the VISUAL INDEX or playback screen is displayed.

(CAMERA SET) menu

Settings to adjust your camcorder to the recording conditions (GAIN SET/STEADYSHOT, etc.)

The default settings are marked with ►.
The indicators in parentheses appear when the items are selected.

See page 66 for details on selecting menu items.

Press the MENU button → select  (CAMERA SET) with the SEL/PUSH EXEC dial.

GAIN SET

You can set gain values for H, M and L positions of the GAIN switch.

Default setting:

[H]: 18 dB, [M]: 9 dB, [L]: 0 dB

- ① Select [H], [M] or [L] with the SEL/PUSH EXEC dial.
- ② Set the gain value with the SEL/PUSH EXEC dial, and press the dial.
You can select a value between 0 dB and 30 dB in 3 dB increments. The larger the value, the higher the gain.
- ③ Select [OK] with the SEL/PUSH EXEC dial.
- ④ Press the MENU button to hide the menu screen.

AGC LIMIT

You can select the upper limit for the Auto Gain Control (AGC).

►OFF, 27dB, 24dB, 21dB, 18dB, 15dB, 12dB, 9dB, 6dB, 3dB, 0dB

Notes

- If you adjust the gain manually, you cannot obtain the effect of [AGC LIMIT].

WB PRESET

You can use the preset white balance. For more details, see page 33.

WB OUTDOOR LEVEL

You can set an offset value to adjust the outdoor white balance when you set [WB PRESET] to [OUTDOOR].

-7 - ►0 - +7
(bluish - normal - reddish)

WB TEMP SET

You can set the color temperature when you set [WB PRESET] to [MANU WB TEMP]. Temperature range: 2300K to 15000K in 100K increments.

BLACK BALANCE

See page 34.

AE SHIFT

■ ON/OFF

You can turn on or off the function. When [ON] is selected, the selected value (-2.0EV for example) appears on the screen.

■ LEVEL

You can set an offset value to adjust the automatic exposure adjustment value with the SEL/PUSH EXEC dial.

-2.0EV ⇄ ►0EV ⇄ +2.0EV
(dark - standard - bright)

Notes

- This function is not effective while you adjust the iris, shutter speed and gain all manually.

Tips

- You can assign an ASSIGN button to work as [ON/OFF] (p. 48).

Press the MENU button → select  (CAMERA SET) with the SEL/PUSH EXEC dial.

STEADYSHOT

NEX-FS100EK/FS100PK only

▶ STANDARD

Uses SteadyShot under relatively stable condition.

ACTIVE

Uses SteadyShot with more powerful effect.

OFF

Does not use SteadyShot. This setting is recommended when you use a tripod.

Notes

- [ACTIVE] can be selected when recording movies using a lens with optical SteadyShot complying with [ACTIVE].
- You cannot set [STEADYSHOT] when an E16 mm F2.8 lens (sold separately) or an A-mount lens (sold separately) is attached.

Tips

- You can assign this function to an ASSIGN button (p. 48).

SMOOTH SLOW REC

See page 45.

S&Q MOTION

See page 46.

COLOR BAR

■ ON/OFF

▶ OFF

Does not display color bars.

ON

Displays color bars on the screen, records them on recording media, and outputs tone signals.

This function helps you to adjust colors when you view movies recorded with your camcorder on a TV or a monitor.

Notes

- This function is automatically set to [OFF] when you switch the format, perform the function by the MENU button, or turn off the camcorder.
- You cannot change the setting during recording or expanded focus operation.
- The time code does not advance while recording the color bars.

■ TONE

▶ OFF

Does not output audio tone signals.

ON

Outputs audio tone signals (1 kHz: full bit -18 dB). Set [ON/OFF] to [ON], too.

Tips

- You can assign an ASSIGN button to work as [ON/OFF] (p. 48).
- If you record color bars with [TONE] set to [OFF], the camcorder records sound from the microphone.

↔ (REC/OUT SET)

menu

Recording settings, input and output settings (REC SET/VIDEO OUT)

The default settings are marked with ►.
The indicators in parentheses appear when the items are selected.

See page 66 for details on selecting menu items.

Press the MENU button → select
↔ (REC/OUT SET) with the SEL/PUSH
EXEC dial.

REC SET

You can select a recording format.

■ **[HD]/[SD] SET**

See page 28.

■ **[HD] REC FORMAT**

See page 28.

■ **[HD] SIMULTANEOUS REC**

See page 27.

■ **[HD] REC MEDIA SETTING**

See page 27.

■ **[SD] WIDE REC**

You can set the aspect ratio when recording in standard definition image quality (SD).

► **ON**

Records in 16:9.

OFF (4:3)

Records in 4:3.

🔊 Notes

- When recording in high definition image quality (HD), the aspect ratio is fixed to 16:9.

VIDEO OUT

■ **HDMI/COMPONENT**

You can select the resolution of the output signal from the HDMI/COMPONENT jacks.

1080p/576i

720p/576i

► **1080i/576i**

576p

576i

■ **DOWN CONVERT TYPE**

You can select a down convert type when you down-convert video signal.

Use this function for outputting movies and still images recorded in 16:9.

► **SQUEEZE**

Outputs a horizontally compressed image while maintaining its original height.

LETTER BOX(16:9)

Outputs a vertically compressed image while maintaining its original aspect ratio.

EDGE CROP

Outputs the central portion of the original image by cropping its right and left edges.

■ **[SD] WIDE CONVERT**

You can select a down convert type when you down-convert video signal.

Use this function for outputting SD movies recorded with [**[SD] WIDE REC**] set to [ON].

► **SQUEEZE**

Outputs a horizontally compressed image while maintaining its original height.

LETTER BOX(16:9)

Outputs a vertically compressed image while maintaining its original aspect ratio.

EDGE CROP

Outputs the central portion of the original image by cropping its right and left edges.

🔊 Notes

- When you view a movie recorded in standard definition image quality (SD) with [HSD] WIDE REC set to [ON] on a standard 4:3 TV, images may appear horizontally compressed while maintaining its original height. In such a case, select [LETTER BOX(16:9)] or [EDGE CROP].
- If you change the setting from [SQUEEZE] to another option, or from another option to [SQUEEZE], the screen will go out momentarily, and the image and sound will be intermitted.

■ HDMI TC OUT

▶ OFF

Does not carry the time code on the HDMI signal.

ON

Carries the time code on the HDMI signal. The camcorder transmits the time code as digital data, not as a video signal to be displayed on the screen. The connected device can read the time code by referring to the data.

🎵 (AUDIO SET) menu

Settings for the audio recording
([HSD] AUDIO FORMAT/XLR SET, etc.)

The default settings are marked with ▶. The indicators in parentheses appear when the items are selected.

See page 66 for details on selecting menu items.

Press the MENU button → select 🎵 (AUDIO SET) with the SEL/PUSH EXEC dial.

[HSD] AUDIO FORMAT

You can set the audio format for high definition image quality (HD) recording.

▶ LINEAR PCM (🎵LPCM)

Records in Linear PCM system.

DOLBY DIGITAL (🎵DolbyD)

Records in Dolby Digital system.

🔊 Notes

- Audio format is fixed to [DOLBY DIGITAL] with the standard definition image quality (SD) recording.

AUDIO LIMIT

You can set the clipping-noise reduction function for CH1/CH2.

▶ OFF

Disables the function.

ON

Enables the function.

🔊 Notes

- This function is available only when you set the AUTO/MAN (CH1/CH2) switches to MAN.

HEADPHONE OUT

You can set the sound to output to the headphone when the HEADPHONE MONITOR switch is set to STEREO MIX.

▶ STEREO

Outputs in stereo.

MONO

Outputs in monaural.

XLR SET

■ XLR AGC LINK

You can select either linked or separate AGC (Auto Gain Control) of CH1 and CH2 when using an external microphone.

► SEPARATE

Separately applies the AGC for CH1/CH2. Sound inputs from CH1/CH2 will be recorded as separate sound.

LINKED ()

Applies the AGC of CH1 linked with that of CH2. Sound inputs from CH1/CH2 will be recorded as a set of sound such as stereo sound. A  appears on the status check screen.

Notes

- This function is available when the CH1 and CH2 switches are set to AUTO and the INPUT 1 and INPUT 2 switches are both set to MIC or both set to LINE (p. 35).

■ INPUT1 TRIM

You can adjust the input signal level from INPUT 1.

-18dB, -12dB, -6dB, ►0dB, +6dB, +12dB

Notes

- The setting is not effective when you set the INPUT 1 switch to LINE.

■ INPUT1 WIND

► OFF

Disables wind noise reduction.

ON

Enables wind noise reduction.

 appears on the status check screen.

Notes

- The setting is not effective when you set the INPUT 1 switch to LINE.

■ INPUT2 TRIM

■ INPUT2 WIND

You can set INPUT 2 in the same way as INPUT 1.

Tips

- -48 dBu is set as 0 dB in your camcorder.
- Set INPUT TRIM to [0dB] for the supplied microphone.
- The INPUT TRIM function adjusts the input level from an external microphone. When using a highly sensitive microphone or recording loud sound, set this to the minus side. When using a less sensitive microphone or recording quiet sound, set it to the plus side.
- When recording loud sound, the sound may be distorted at either the input point or the recording point. If it is distorted at the input point, adjust the sound using the INPUT TRIM function. If it is distorted at the recording point, lower the total volume level manually.
- If you set INPUT TRIM too far to the minus side, the microphone volume becomes too low, resulting in a poor signal to noise ratio.
- Test the effect of [XLR SET] according to the microphone used or the sound field of the recording site before actual recording.

■ (DISPLAY SET) menu

Display settings (MARKER/DISPLAY OUTPUT, etc.)

The default settings are marked with ►. The indicators in parentheses appear when the items are selected.

See page 66 for details on selecting menu items.

Press the MENU button → select ■ (DISPLAY SET) with the SEL/PUSH EXEC dial.

HISTOGRAM

The histogram displays the luminance distribution that shows how many pixels of a particular brightness exist in the image.

► OFF

Does not display the histogram.

ON

Displays a histogram. A line appears at the 100% position, and the color of the zone above the line changes.

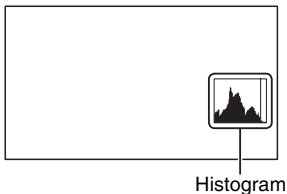

ON[ZEBRA POINT]

The histogram shows the point where the zebra pattern appears. A line is displayed at the brightness level set with [ZEBRA].

💡 Tips

- You can assign this function to an ASSIGN button (p. 48).

ZEBRA

You can display a zebra pattern as a guide for adjusting brightness.

■ ON/OFF

► OFF

Does not display the zebra pattern.

ON

Displays ■ and the brightness level appear on the screen. The zebra pattern will not be recorded with the image.

■ LEVEL

You can select the brightness level.

►70 to 100 or 100+.

💡 Tips

- The zebra pattern is a strip pattern displayed over a part of an image on the screen when the part is higher than the preset brightness level.
- You can assign an ASSIGN button to work as [ON/OFF] (p. 48).

PEAKING

■ ON/OFF

► OFF

Does not display the peaking.

ON

PEAKING appears and you can display an image on the screen with its outlines enhanced. This function helps you to adjust the focus.

■ COLOR

You can select peaking color.

►WHITE, RED, YELLOW

■ LEVEL

You can select a peaking sensitivity.

HIGH, ►MIDDLE, LOW

🔍 Notes

- The enhanced outlines will not be recorded on the recording media.

💡 Tips

- You can focus more easily using this function in combination with the expanded focus function (p. 30).
- You can assign an ASSIGN button to work as [ON/OFF] (p. 48).

MARKER

■ ON/OFF

▶ OFF

Does not display markers.

ON

Displays markers. Markers are not recorded on the recording media.

■ CENTER

▶ ON

Displays a marker at the center of the screen.

OFF

Does not display a center maker.



■ ASPECT

▶ OFF

Does not display the aspect ratio.

4:3, 13:9, 14:9, 15:9

Displays markers at boundaries of display area defined by the aspect ratio.



■ SAFETY ZONE

▶ OFF

Does not display the safety zone.

80%, 90%

If you select either one, you can display markers at boundaries of display area that regular home TVs can display.



■ GUIDEFRAME

▶ OFF

Does not display the guide frame.

ON

You can display frame markers that help you to check horizontal and vertical positions of a subject.



🔊 Notes

- Only the time code is output to an external device via external output jacks when [MARKER] is set to [ON], even if [DISPLAY OUTPUT] is set to [ALL OUTPUT].
- You cannot display markers under following conditions:
 - [EXPANDED FOCUS]
 - During [SMOOTH SLOW REC]
- You can display markers only on the LCD screen. You cannot display them on an external device.

💡 Tips

- You can display all types of markers at the same time.
- You can obtain a balanced composition by positioning the subject at the cross points of the guideframe marker.
- You can assign an ASSIGN button to work as [ON/OFF] (p. 48).

CAMERA DATA DISPLAY

OFF

Does not display the iris, gain and shutter speed settings.

▶ ON

Constantly displays the iris, gain and shutter speed settings on the screen.

Press the MENU button → select  (DISPLAY SET) with the SEL/PUSH EXEC dial.

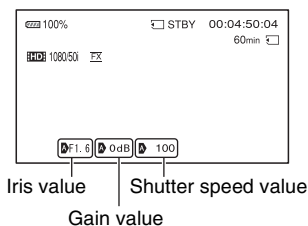

Tips

- The settings appear on the screen during the manual adjustment regardless of the settings of this function.
-  indicates that the settings are automatically adjusted values.
- The displayed settings are different from the settings that will be displayed when you press the DATA CODE button (p. 54).

AUDIO LEVEL DISPLAY

▶ ON

Displays the audio level meters on the screen.

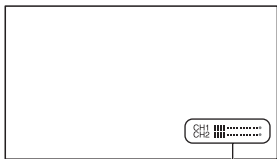

Audio level meters

OFF

Does not display the audio level meters.

Tips

- You can assign this function to an ASSIGN button (p. 48).

ZOOM DISPLAY

▶ BAR

Displays a bar that indicates the zoom position.

NUMBER

Displays a number (0 through 99) that indicates the zoom position.

LCD BRIGHT

You can adjust the brightness of the LCD screen. Changes in the LCD brightness will not affect the brightness of recording images.

DISPLAY OUTPUT

You can select where to output the display information, such as time code.

▶ LCD PANEL

Outputs the information to the LCD screen.

ALL OUTPUT

Outputs the information to the LCD screen, HDMI output, component output and video output.

Notes

- Only the time code is output when [MARKER] is set to [ON] and a marker is displayed on the screen.

00:00 (TC/UB SET) menu

Time code settings (TC PRESET/UB PRESET, etc.)

The default settings are marked with ►. The indicators in parentheses appear when the items are selected.

See page 66 for details on selecting menu items.

Press the MENU button → select 00:00 (TC/UB SET) with the SEL/PUSH EXEC dial.

TC PRESET

See page 44.

UB PRESET

See page 44.

TC RUN

You can select how the time code advances.

► REC RUN

Advances the time code only during recording.

Select this setting to record the time code sequentially from the last time code of the previous recording.

FREE RUN

Advances the time code regardless of operation of your camcorder.

ⓘ Notes

- Even if the time code advances in the [REC RUN] mode, the time code may not be recorded sequentially in the following cases:
 - When the recording format is changed.
 - When the images are recorded on the memory card and the flash memory unit simultaneously.
 - When the recording media is removed.
- [REC RUN] is selected automatically for the Slow & Quick Motion recording.

TC MAKE

► PRESET

Records the newly set time code on the recording media.

REGENERATE

Reads the last time code of the previous recording from the recording media and records the new time code consecutively from the last time code during the backspace editing.

The time code runs in [REC RUN] mode regardless of the setting of [TC RUN].

UB TIME REC

► OFF

Does not save the actual time in the user bit code.

ON

Saves the actual time in the user bit code.

ⓘ Notes

- The last 2 digits are fixed to 00 when it is set to [ON].

(OTHERS) menu

Settings while recording or other basic settings (AREA SET/BEEP, etc.)

The default settings are marked with ►. The indicators in parentheses appear when the items are selected.

See page 66 for details on selecting menu items.

Press the MENU button → select  (OTHERS) with the SEL/PUSH EXEC dial.

ASSIGN BUTTON

See page 48.

CLOCK SET

See page 21.

AREA SET

You can adjust a time difference without stopping the clock. When you use your camcorder abroad, you can adjust the clock to the local time.

SUMMERTIME

You can change this setting without stopping the clock. Set to [ON] to move the time forward 1 hour.

► OFF

Does not set the summertime.

ON

Sets the summertime.

LANGUAGE

You can select the language to be used on the LCD screen.

Tips

- Your camcorder offers [ENG[SIMP]] (simplified English) in case that you cannot find your native tongue among the options.

GPS SETTING

See page 43.

GPS INFORMATION

The camcorder displays the triangulating information.

Satellite icons

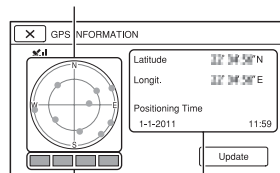

Triangulating gauge

Information for the location that was previously obtained.

How to check the triangulating information

Color of the satellites/ triangulating gauge	Status
●/■ (black)	No signal, but orbit information for the satellite is available.
●/■ (gray)	33% of the satellite orbit information has been obtained.
●/■ (brown)	66% of the satellite orbit information has been obtained.
●/■ (ocher)	99% of the satellite orbit information has been obtained.
●/■ (green)	Triangulating is completed and the satellite is currently being used.

If data on your current location cannot be obtained

When you cannot obtain your current location, a display that allows you to triangulate the location again appears. In this case, follow the instructions that appears on the LCD screen.

To obtain your current location manually

Touch [Update] to triangulate the location.

To close the triangulating information screen

Touch [X].

AUTO CLOCK ADJ

The camcorder can maintain accurate time automatically by acquiring time information from the GPS system.

▶ ON

Maintains accurate time automatically.

OFF

Does not maintain accurate time using the GPS system.

⚡ Notes

- You must set the date and time on your camcorder before using your camcorder (p. 21).
- There may be discrepancies of a few seconds even if [AUTO CLOCK ADJ] is activated.
- This function automatically adjusts the clock when the camcorder receives GPS signals and finishes triangulating successfully while the power is on. Once the clock is adjusted, it will not be adjusted until the next time you turn the camcorder on again.
- The clock may not be adjusted to the correct time automatically using the GPS system, depending on the country/region selected for your camcorder. In this case, set [AUTO CLOCK ADJ] to [OFF].

AUTO AREA ADJ

The camcorder can compensate for time differences automatically by acquiring location information from the GPS system.

▶ ON

Compensates for time differences automatically.

OFF

Does not compensate for time differences automatically.

⚡ Notes

- You must set the date and time on your camcorder before using your camcorder (p. 21).
- There may be discrepancies of a few seconds even if [AUTO AREA ADJ] is activated.
- The camcorder may not compensate for the time difference automatically, depending on the country/region selected for your camcorder. In this case, set [AUTO AREA ADJ] to [OFF].

DATE REC

▶ OFF

Does not superimpose the date and time on images.

ON

Superimposes the date and time on images.

💡 Tips

- You can set this item when the interlace scanning system is selected.
- When zebra or peaking is activated, the date and time characters are affected by the signal, but properly recorded on images.

BEEP

▶ OFF

Cancels the melody.

ON

Activates a melody when you start/stop recording, or when you are warned with warning indicators, etc.

Press the MENU button → select  (OTHERS) with the SEL/PUSH EXEC dial.

REC LAMP[F] (Recording lamp [front])

▶ ON

Turns on the front camera recording lamp.

OFF

Turns off the front camera recording lamp.

Tips

- You can assign this function to an ASSIGN button (p. 48).

REC LAMP[R] (Recording lamp [rear])

▶ ON

Turns on the rear camera recording lamp.

OFF

Turns off the rear camera recording lamp.

Tips

- You can assign this function to an ASSIGN button (p. 48).

REMOTE CONTROL

▶ ON

Enables the supplied Wireless Remote Commander (p. 119).

OFF

Disables the supplied Wireless Remote Commander.

MEDIA FORMAT

See page 63.

REPAIR IMAGE DB FILE

See page 65.

USB CONNECT

Select this item when [USB CONNECT] does not appear on the LCD screen by connecting the camcorder to another device with the USB cable.

OPERATION TIME

Displays the total hours of operation in 10-hour increments.

CALIBRATION

See page 108.

Saving images on an external media device

You can save movies and still images on an external media device (USB storage devices), such as an external hard disk drive. You can also play back images on the camcorder or another playback device.

🔊 Notes

- Refer to the instruction manuals supplied with the external media device.

💡 Tips

- You can import images saved on the external media device to your computer by using the supplied software “Content Management Utility.”

Functions available after saving images on an external media device

- playback of images through the camcorder (p. 84)
- importing images to a computer

Devices that cannot be used as an external media device

You cannot use the following devices as an external media device.

- media devices with a capacity exceeding 2 TB
- ordinary disc drive such as CD or DVD drive
- media devices connected via a USB hub
- media devices with built-in USB hub
- card reader

🔊 Notes

- You may not be able to use external media devices with a code function.
- The FAT file system is available for your camcorder. If the storage medium of the external device was formatted for the NTFS file system, etc., format the external media device using the camcorder before use. The format screen appears when an external media device is connected to your camcorder. Make sure that important data has not previously been saved on the external media device before you format it using the camcorder.

- Operation is not assured with every device satisfying requirements for operating.
- For details on available external media devices, go to the Sony support website in your country/region.

1 Connect the AC Adaptor/Charger and the power cord (mains lead) to the DC IN jack of your camcorder and the wall outlet (wall socket) (p. 17).

2 If the external media device has the AC power cable, connect it to the wall outlet (wall socket).

3 Connect the USB Adaptor Cable (supplied) to the external media device.

4 Connect the USB Adaptor Cable (supplied) to the Ψ (USB) jack of your camcorder.

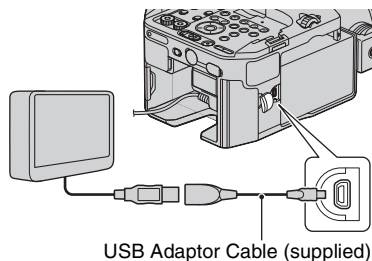

5 Touch [Copy.] on the camcorder screen.

6 Select [MEMORY CARD] or [FMU] that contains the images you want to save.

Images that have not yet been saved on an external media device are saved on the connected media device at this time.

- This operation is available only when there are newly recorded images.

7 After the operation is completed, touch [OK] on the camcorder screen.

Notes

- The number of scenes you can save on the external media device are as follows. Even if the external media device has free space, you cannot save scenes exceeding the following number. The number of scenes may be smaller depending on the camcorder setting and the type of images recorded.
 - High definition image quality (HD) movies: Max. 3,999
 - Standard definition image quality (STD) movies: Max. 9,999
 - Still images: Max. 40,000

Playing back images in the external media device on the camcorder

When the camcorder is connected to the external media device, the images saved in the external media device are displayed on the LCD screen of the camcorder. The recording media icon on the VISUAL INDEX screen changes as follows.

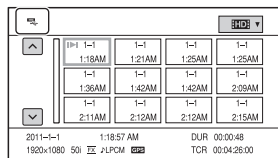

You can make menu settings of the external media device such as deleting images. Press the MENU button and select the [EDIT] menu.

Creating a high definition image quality (HD) disc with a DVD writer

Use the USB cable to connect your camcorder to a DVD writer. Refer also to the instruction manuals supplied with the device to be connected.

Notes

- Sony DVD writer may not be available in some countries/regions.

1 Connect the AC Adaptor/Charger and the power cord (mains lead) to the DC IN jack of your camcorder and the wall outlet (wall socket) (p. 17).

2 Turn on your camcorder, and connect a DVD writer, etc. to the Ψ (USB) jack of your camcorder with the USB cable (supplied).

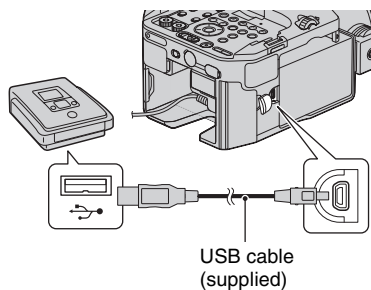

The [USB CONNECT] screen appears on the camcorder screen.

- If the [USB CONNECT] screen does not appear, press the MENU button, and select [OTHERS] → [USB CONNECT].

3 Record movies on the connected device.

For details, refer to the instruction manuals supplied with the device to be connected.

4 After the operation is completed, touch \boxtimes → [YES] on the camcorder screen.

5 Disconnect the USB cable.

Creating a standard definition image quality (SD) disc with a recorder, etc.

You can copy images played back on your camcorder on a disc or video cassette, by connecting your camcorder to a disc recorder, a Sony DVD writer, etc., other than DVDirect Express, with the A/V connecting cable. Refer also to the instruction manuals supplied with the devices to be connected.

⚡ Notes

- Connect your camcorder to the wall outlet (wall socket) using the supplied AC Adaptor/Charger for this operation (p. 17).
- Sony DVD writer may not be available in some countries/regions.
- High definition image quality (HD) movies will be copied with standard definition image quality (SD).

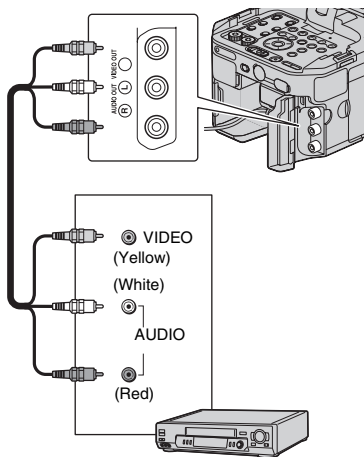

1 Insert the recording media in the recording device.

If your recording device has an input selector, set it to the input mode.

2 Connect your camcorder to the recording device (a disc recorder,

etc.) with the A/V connecting cable (supplied).

Connect your camcorder to the input jacks of the recording device.

3 Start playback on your camcorder, and record it on the recording device.

Refer to the instruction manuals supplied with your recording device for details.

4 When copy is finished, stop the recording device, and then your camcorder.

⚡ Notes

- Since copying is performed via analog data transfer, the image quality may deteriorate.
- You cannot copy images to recorders connected with an HDMI cable.
- When you do not want to display the counter, etc. on the screen of the connected device, press the MENU button, and select [DISPLAY SET] → [DISPLAY OUTPUT] → [LCD PANEL].
- To copy date/time information, camera data, and coordinates, press the DATA CODE button and make a desired setting. In addition, press the MENU button, select [DISPLAY SET] → [DISPLAY OUTPUT] → [ALL OUTPUT].
- When the screen size of display devices (TV, etc.) is 4:3, set [DOWN CONVERT TYPE] (p. 73).
- When you connect a monaural device, connect the yellow plug of the A/V connecting cable to the video input jack, and the white (left channel) or the red (right channel) plug to the audio input jack on the device.

Saving images with a computer

Preparing a computer (Windows)

You can perform following operations using “Content Management Utility.”

- Importing images to a computer
- Viewing imported images
- Detecting and correcting flash bands

To save movies using a computer, install the software from the supplied CD-ROM “Content Management Utility” beforehand. Use commercially available software to edit images or create discs.

Step 1 Checking the computer system

OS* ¹
Microsoft Windows XP SP3* ² /Windows Vista SP2* ³ /Windows 7
CPU
To play back movies with high definition image quality (HD) in the highest image quality mode, use an Intel Core 2 Duo 2.80 GHz CPU or faster. Movies with high definition image quality (HD) recorded in other than the highest image quality mode may be played back with a slower CPU. Depending on the performance of your video card, videos with high definition image quality (HD) recorded using the highest image quality mode may be played back with a slower CPU than that recommended above. For the following operations, an Intel Pentium III 1GHz or faster is sufficient. – Importing movies to a computer – Handling movies with standard definition image quality (SD) only
Memory
Windows XP: 512 MB or more (1 GB or more is recommended.) Windows Vista/Windows 7: 1 GB or more

Hard disk
Disk volume required for installation: Approximately 100 MB Only the NTFS or exFAT file system can be used for importing videos or registering them for viewing.
Display
Minimum 1,024 × 768 dots
Others
USB port (this must be provided as standard, High-Speed USB (USB 2.0 compatible)) (CD-ROM drive is necessary for installation)

*1 Standard installation is required. Operation is not assured if the OS has been upgraded or in a multi-boot environment.

*2 64-bit editions and Starter (Edition) are not supported.

*3 Starter (Edition) is not supported.

⚙ Notes

- Operation with all computer environments is not assured.
- The supplied software “Content Management Utility” is not supported by Macintosh computers.

Step 2 Installing the supplied software “Content Management Utility”

Install “Content Management Utility” before connecting your camcorder to a computer.

- ① Confirm that your camcorder is not connected to the computer.
- ② Turn on the computer.
 - Log on as an Administrator for installation.
 - Close all applications running on the computer before installing the software.
- ③ Place the supplied CD-ROM “Content Management Utility” in the disc drive of your computer.
The installation screen appears.
 - If the screen does not appear, click [Start] → [Computer] (in Windows XP, [My

Saving images with a computer (Continued)

Computer)], then double-click [SONYCMU(E:)] (CD-ROM).

- ④ Select the language for the application to be installed, then click [OK].
- ⑤ When the install wizard screen appears, click [Next].
- ⑥ Confirm the license agreement, and if you accept the terms, click [Next].
- ⑦ Select the drive or folder to install the application, then click [Next].
- ⑧ Select the option to create the desk-top shortcut, then click [Next].
- ⑨ Turn on your camcorder, then connect the camcorder to the computer using the supplied USB cable.

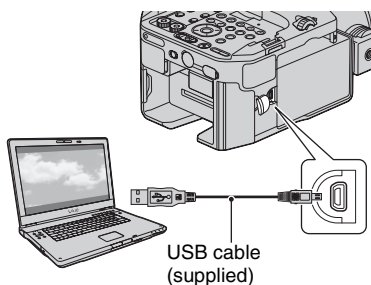

The [USB CONNECT] screen appears on the camcorder screen automatically.

- ⑩ Click [Next].
- ⑪ Follow the on-screen instructions to install the software.
 - Restart the computer if required to complete the installation.

When the installation is completed, the following icon will appear, depending on the selection in step ⑧.



- ⑫ Remove the CD-ROM from the computer.

To disconnect your camcorder from the computer

- ① Click the  icon at the bottom right of the desktop of the computer → [Safely remove USB Mass Storage Device-Drive].



- ② Touch → [YES] on the camcorder screen.
- ③ Disconnect the USB cable.

Notes

- Use the supplied "Content Management Utility" software when you import long movies or edited images from the camcorder to a computer. If you use other software, the images may not be imported correctly.
- If file size exceeds 2 GB during a long recording, a new file is created automatically, resulting in the movie being divided into multiple files when you view the recording media directly from your computer after recording.
- The camcorder automatically divides an image file that exceeds 2 GB or larger and saves the parts as separate files. All image files may be shown as separate files on a computer, however, the files will be handled properly by the import function of the camcorder or the "Content Management Utility" software.

Troubleshooting

If you run into any problems using your camcorder, follow the flow chart below.

① Check your camcorder, referring to the items on pages 89 to 96.

② Disconnect the power source, reconnect the power source after about 1 minute and turn on your camcorder.

③ Press the RESET button (p. 118) with a pointed object, then turn on your camcorder. This operation will reset the date, time and area settings.

④ Consult your Sony dealer or local authorized Sony service facility.

- Power sources/LCD screen/Wireless Remote Commander...p. 89
- Memory card/flash memory unit...p. 91
- Recording...p. 91
- Playback...p. 94
- Connecting to TV...p. 94
- Copying/Editing/Connecting to other devices...p. 95
- GPS...p. 96
- Connecting to a computer...p. 96

Power sources/LCD screen/Wireless Remote Commander

The power does not turn on or abruptly turns off.

- Attach a charged battery pack to the camcorder (p. 15).
- Use the AC Adaptor/Charger to connect the camcorder to a wall outlet (wall socket) (p. 15).

The camcorder does not operate even when the power is set to on.

- Disconnect the AC Adaptor/Charger from the wall outlet (wall socket) or remove the battery pack, then reconnect it after about 1 minute.
- Press the RESET button (p. 118) using a pointed object.

The camcorder gets warm.

- The camcorder may get warmer while you use it. This is not a malfunction.

The remaining battery time indicator does not indicate the correct figure.

- Ambient temperature is too high or too low, or the battery pack has not been charged enough. This is not a malfunction.
- Fully charge the battery again. If the problem persists, the battery may be worn-out. Replace it with a new one (p. 15, 105).

Troubleshooting (Continued)

- The indicated figure may not be correct in certain circumstances. For example, when you open or close the LCD screen, it takes about 1 minute to display the correct remaining battery.

The battery pack discharges too quickly.

- Ambient temperature is too high or low, or the battery pack has not been charged enough. This is not a malfunction.
- Fully charge the battery again. If the problem persists, the battery may be worn-out. Replace it with a new one (p. 15, 105).

The image on the LCD screen is not clear.

- When the large LCD viewfinder is attached, turn the viewfinder lens adjustment ring until the image appears clearly (p. 13).

The supplied Wireless Remote Commander does not function.

- Set [REMOTE CONTROL] to [ON] (p. 82).
- Remove any obstructions between the Wireless Remote Commander and the remote sensor of the camcorder.
- Keep strong light sources, such as sunlight or overhead lighting, away from the remote sensor, otherwise the Wireless Remote Commander may not function properly.
- Insert a fresh battery in the compartment with its +/- terminals matching those of the compartment (p. 119).

Another video device malfunctions when you use the supplied Wireless Remote Commander.

- Select a commander mode other than DVD2 for your video device.
- Cover the sensor of your video device with black paper.

When a device is connected to the REMOTE jack, the camcorder or the device does not operate properly.

- The connected device may react slowly to some operations.
- If you disconnect the cable from the device while the cable is still connected to the camcorder's REMOTE jack, the camcorder may not restore the proper settings. Disconnect the cable also from the camcorder's REMOTE jack.

Memory card/flash memory unit

The camcorder does not operate with the memory card inserted.

- The memory card was formatted on a computer. Format it on this camcorder (p. 63).

The data file name is incorrect, or flashing.

- The file is damaged.
- Use a file format supported by your camcorder (p. 102).

The recording media indicator is flashing.

- Something wrong happened to recording media. Stop recording of all recording media, and repair the database file.

Images on the recording media cannot be deleted.

- You can select no more than 100 images to be deleted on the edit screen.
- The images are protected. Unprotect the images (p. 58).

Recording

The recording does not start when you press the START/STOP button.

- The playback screen is displayed. Finish playback operation (p. 50).
- There is no empty space on the recording media. Replace the recording media with a new one, delete unnecessary images (p. 61) or format the recording media (p. 63).
- Total number of movie scenes exceeds the recordable capacity of your camcorder (p. 100). Delete unnecessary images (p. 61).
- The temperature of your camcorder is extremely high. Turn off your camcorder and leave it for a while in a cool place.
- The temperature of your camcorder is extremely low. Turn off your camcorder and leave it for a while in a warm place.
- Something wrong happened to one of recording media. Stop recording of all recording media, and repair the database file.

The access lamp remains lit even after recording was stopped.

- Your camcorder is recording the scene you have just shot on the memory card.

The imaging field looks different.

- The imaging field may look different depending on the condition of your camcorder. This is not a malfunction.

The actual recording time for movies is less than the estimated recording time of the recording media.

- Depending on the recording conditions, the time available for recording may be shorter, for example when recording a fast moving object, etc. (p. 99).

The camcorder does not keep the setting changes.

- Some menu items return to the default setting when the power is turned off (p. 68).
 - The [EXPANDED FOCUS] setting are not stored.
 - You disconnected the power sources when the POWER switch was set to ON. Before disconnecting the battery or the AC Adaptor/Charger, set the POWER switch to OFF and make sure that the access lamp is turned off.
-

There is a time difference between the point when the START/STOP button is pressed and the point that the recording movie is started or stopped actually.

- On your camcorder, there may be a slight time difference between the point where you press the START/STOP button and the actual point that recording movie starts/stops. This is not a malfunction.
-

The aspect ratio (16:9 (wide)/4:3) cannot be changed.

- The aspect ratio of high definition image quality (HD) movies is 16:9 (wide).
-

Automatic focus does not function.

- Set the FOCUS switch to AUTO to enable the automatic focus function (p. 29).
 - Adjust the focus manually if the automatic focus does not work properly (p. 29).
 - Use an E-mount lens (p. 18).
-

Menu items are grayed out or do not work.

- You cannot select grayed out display items in the current recording/playback situation.
- There are some functions you cannot activate simultaneously. The following list shows examples of unworkable combinations of functions and menu items.

Cannot use	Situation
[ON/OFF] of [AE SHIFT]	All of iris, gain, and shutter speed are set manually.
[ZEBRA], [PEAKING]	[COLOR BAR] is set to [ON].
[ON/OFF] of [MARKER]	[EXPANDED FOCUS] is set to [ON].
[TC PRESET]	[TC MAKE] is set to [REGENERATE].
[COLOR BAR]	Movies are being recorded. [EXPANDED FOCUS] is set to [ON].

Iris, gain, shutter speed, or white balance cannot be adjusted manually.

- Set the AUTO/MANUAL switch to MANUAL.

Tiny spots in white, red, blue, or green appear on the screen.

- This phenomenon appears when using a slow shutter speed (p. 32). This is not a malfunction.

The subjects passing by the frame very fast appear crooked.

- This is called the focal plane phenomenon. This is not a malfunction. Because of the way that the image device (CMOS sensor) reads out image signals, the subjects passing by the frame rapidly might appear crooked depending on the recording conditions.

Horizontal stripes appear on the image.

- This occurs when recording pictures under a fluorescent lamp, sodium lamp, or mercury lamp. This is not a malfunction. This can be improved by changing the shutter speed (p. 32).

The image appears divided horizontally.

- This occurs when you light the subject using a flash. This may be avoided by using a shutter speed as slow as possible (p. 32).
- You may try using the “Content Management Utility” software on the supplied CD-ROM to repair the image.

Black bands appear when you record a TV screen or computer screen.

- This can be improved by adjusting the shutter speed (p. 32).

Fine patterns flicker, diagonal lines look jagged.

- Adjust [DETAIL] to the negative side (p. 42).

The time code is not recorded in sequence.

- The time code may not be recorded sequentially if you change the settings of [HD/SD] SET and [HD] REC FORMAT.

Playback

Refer also to the “Memory card/flash memory unit” section (p. 91).

The desired images cannot be found. Images cannot be played back.

- Select the recording media and image quality of the image you want to play back on the VISUAL INDEX screen (p. 50).
- Image data cannot be played back if you have modified file names or folders, or have edited the data on a computer (When viewing still images, the file name flashes). This is not a malfunction (p. 105).
- Images recorded on other devices may not be played back, or displayed in incorrect size. This is not a malfunction.
- Display the VISUAL INDEX screen, touch twice on the thumbnail of the image you want to play back, or select the thumbnail with ◀/▶/⏪/⏩ buttons and press the EXEC button (p. 51).

The data file name is displayed incorrectly, or flashing.

- The file is damaged.
- The file format is not supported on your camcorder (p. 102).
- Only the file name is displayed, if the folder structure does not conform to the universal standard.

No sound or only a low sound is heard.

- Turn up the volume (p. 52).
- Movies recorded with the SMOOTH SLOW REC function do not have sounds.

“---” is displayed on the screen.

- Bars will be displayed for the camera data of the movies recorded with the SMOOTH SLOW REC function or [COLOR BAR] set to [ON].
- Bars will be displayed for the exposure compensation value and flash information of the still images created with [PHOTO CAPTURE].

Multi ch appears on the LCD screen.

- This appears when you play back movies recorded with 5.1ch surround sound. 5.1ch surround sound is down-mixed to 2ch stereo and played back on your camcorder.

Connecting to TV

Neither image nor sound is played back on the TV connected with the component video cable.

- Set [VIDEO OUT] according to the requirements of the connected device (p. 73).
- When you are using the component video cable, make sure that you connect the red and white plugs of the A/V connecting cable (p. 56).

Neither image nor sound is played back on the TV connected with the HDMI cable.

- Images are not output from the HDMI OUT jack, if copyright protection signals are recorded in the images.
- Signals are not output from the HDMI OUT jack when the USB jack is connected.

Neither image nor sound is played back on the TV, projector, or AV amplifier connected with the HDMI cable.

- If you cannot view images or hear sound on the TV, projector, or AV amplifier connected with the HDMI cable, try disconnecting and connecting the HDMI cable, or turn on your camcorder again.

The image appears distorted on the 4:3 TV.

- This happens when viewing a movie recorded in the 16:9 (wide) mode on a 4:3 TV. Select [REC/OUT SET] → [VIDEO OUT] → [DOWN CONVERT TYPE] → the appropriate down conversion type (p. 73).

Black zone appears at top and bottom of a 4:3 TV screen.

- This happens when viewing a movie recorded in the 16:9 (wide) mode on a 4:3 TV. This is not a malfunction.

Copying/Editing/Connecting to other devices

Time code and other information appear on the display of the connected device.

- Set [DISPLAY OUTPUT] to [LCD PANEL] when you connect a device with the A/V connecting cable (p. 78).

Copy cannot be done correctly using the A/V connecting cable.

- The A/V connecting cable is not connected properly. Make sure that the A/V connecting cable is connected to the input jack of the device.

Sound cannot be added to the recording media after recording.

- You cannot add sound to the recording media after recording on your camcorder.

Copy cannot be done correctly using the HDMI cable.

- You cannot copy movies using the HDMI cable.

GPS

The camcorder is not receiving a GPS signal.

- Your camcorder may not be able to receive radio signals from GPS satellites because of obstructions. Bring your camcorder to an open area. For details on places where radio signals do not reach, see page 103.
 - When you use the camcorder where it is difficult to receive GPS signals, try the triangulating priority mode (p. 80).
-

The triangulating location is different from the actual current location.

- If your camcorder receives the radio signal reflected by surrounding buildings, or weak radio signals, the margin of error can be as wide as several-hundred meters, at a maximum.
-

Connecting to a computer

The computer does not recognize the camcorder.

- Disconnect the cable from the computer, then connect it again securely.
 - Disconnect the cable from your computer and camcorder. Reboot your computer, and connect your computer and camcorder following the steps in the correct order (p. 87)
-

Movies cannot be viewed or copied to the computer.

- Disconnect the cable from the computer, then connect it again.
 - You need to install the supplied “Content Management Utility” to copy movies from your camcorder to your computer (p. 87).
-

The computer freezes.

- Disconnect the cable from your computer and camcorder. Reboot your computer, and connect your computer and camcorder following the steps in the correct order (p. 87).

Warning indicators and messages

Self-diagnosis display/Warning indicators

When an error occurs, a warning indicator appears on the LCD screen. You can fix some problems associated with the symptoms yourself. If the problem persists even after you have tried a couple of times, contact your Sony dealer or local authorized Sony service facility.

C:04:□□

- The battery pack is not an “InfoLITHIUM” battery pack. Use an “InfoLITHIUM” battery pack (p. 105).

C:06:□□

- The battery pack is too hot. Replace the battery pack, or remove the battery pack and put it in a cool place.

C:13:□□

- Remove the recording media. After installing them again, operate your camcorder.

C:32:□□

- Remove the power source. Reconnect it and operate your camcorder again.

E:□□:□□

- Try the steps ② to ④ on page 89.

(Battery level warning)

- The battery pack is nearly used up.
- Depending on the operation, environment, or battery conditions,  may flash, even if around 10% is displayed as the battery remaining figure.

(Warning indicator pertaining to battery pack temperature)

- The battery pack is too hot. Replace the battery pack, or remove the battery pack and put it in a cool place.

(Warning indicator pertaining to memory cards)

Slow flashing

- Free spaces for recording images are running out. For the type of memory cards you can use with your camcorder, see page 23.
- No memory card is inserted (p. 23).

Fast flashing

- There are not enough free spaces for recording images. Delete unnecessary images (p. 61), or format the memory card (p. 63) after storing the images on other media (p. 83).
- The image database file may be damaged (p. 65).

(Warning indicator pertaining to memory card formatting)

- The memory card is damaged.
- The memory card is not formatted correctly (p. 63).

(Warning indicator pertaining to incompatible memory cards)

- Incompatible memory card is inserted (p. 23).

(Warning indicator pertaining to the write-protect of the memory card)

- Access to the memory card was restricted on another device.

FMU (Warning indicator pertaining to a flash memory unit)

Slow flashing

- Free spaces for recording images are running out. For the flash memory unit you can use with your camcorder, see page 24.
- No flash memory unit is attached (p. 24).

Fast flashing

- There are not enough free spaces for recording images. Delete unnecessary images (p. 61), or format the flash memory unit (p. 63) after storing the images on other media (p. 83).
- The image database file may be damaged (p. 65).

FMU (Warning indicator pertaining to a flash memory unit formatting)

- The flash memory unit is damaged.
- The flash memory unit is not formatted correctly (p. 63).

(Warning indicator pertaining to the external media device)

- The image database file may be damaged. Check the database file by pressing the MENU button, then select  (OTHERS) → [REPAIR IMAGE DB FILE] → the recording medium.
- The external media device is damaged.

(Warning indicator pertaining to formatting of the external media device)

- The external media device is damaged.
- Format the external media device correctly.
- If the message still appears, reconnect the external media device, then format it. Note that if you format the external media device, all the recorded movies and photos are deleted.

- If you cannot format the external media device, the external media device may be incompatible with your camcorder, or damaged. Replace it with a new one.

* When [BEEP] is set to [ON] (p. 81), you hear a melody when the warning indicators appear on the screen.

Warning messages

If messages appear on the screen, follow the instructions.

Recording time of movies

Estimated time of recording and playback with each battery pack

Recording time

Approximate time available when you use a fully charged battery pack.

(unit: minute)

Battery pack	Continuous recording time	Typical recording time
NP-F770	340	195
NP-F970	510	290

Notes

- In HD 1080/24p FX recording format
- Using the E 18-200 mm F3.5-6.3 OSS lens
- Using ECM-XM1 connected to the INPUT1 jack
- Using a memory card
- Typical recording time shows the time when you repeat recording start/stop, turning on/off, and so on.
- Times measured when using the camcorder at 25 °C (77 °F).
- The recording and playback time will be shorter when you use your camcorder in low temperatures. It is recommended that you use the camcorder from 10 °C to 30 °C (50 °F to 86 °F).
- The recording and playback time will be shorter depending on the conditions under which you use your camcorder.

Playing time

Approximate time available when you use a fully charged battery pack.

(unit: minute)

Battery pack	
NP-F770	435
NP-F970	660

Notes

- Playing on the LCD screen

Estimated recording time of movies

High definition image quality (HD)

■ When [HD] AUDIO FORMAT is set to [LINEAR PCM]

(unit: minute)

	PS	FX	FH	HQ	LP
1 GB	4 (4)	4 (4)	6 (6)	10 (8)	15 (10)
2 GB	8 (8)	10 (10)	10 (10)	20 (15)	35 (30)
4 GB	15 (15)	20 (20)	25 (25)	45 (35)	70 (60)
8 GB	35 (35)	40 (40)	55 (55)	90 (70)	145 (125)
16 GB	70 (70)	80 (80)	110 (110)	185 (145)	295 (255)
32 GB	145 (145)	170 (170)	225 (225)	375 (295)	590 (510)

■ When [HD] AUDIO FORMAT is set to [DOLBY DIGITAL]

(unit: minute)

	PS	FX	FH	HQ	LP
1 GB	4 (4)	5 (5)	7 (7)	10 (9)	20 (15)
2 GB	9 (9)	10 (10)	10 (10)	25 (15)	45 (35)
4 GB	15 (15)	20 (20)	30 (30)	50 (40)	90 (75)
8 GB	35 (35)	40 (40)	60 (60)	105 (80)	190 (155)
16 GB	75 (75)	90 (90)	120 (120)	215 (165)	380 (310)
32 GB	150 (150)	180 (180)	245 (245)	440 (330)	770 (630)

Recording time of movies (Continued)

Standard definition image quality (SD)

(unit: minute)

	HQ
1 GB	10 (10)
2 GB	25 (25)
4 GB	55 (50)
8 GB	110 (100)
16 GB	225 (210)
32 GB	460 (420)

Notes

- The recordable time may vary depending on the recording conditions, subjects, and [REC SET] (p. 73).
- The number in () is the minimum recordable time.

Tips

- You can record movies of a maximum of 3,999 scenes with high definition image quality (HD), and 9,999 scenes with standard definition image quality (SD).
- Your camcorder uses the VBR (Variable Bit Rate) format to automatically adjust image quality to suit the recording scene. This technology causes fluctuations in the recording time of the media. Movies containing quickly moving and complex images are recorded at a higher bit-rate, and this reduces the overall recording time.
- Bit-rate (movie + audio, etc.), number of pixels, and aspect ratio of each recording mode of movies are as follows.
 - High definition image quality (HD)
PS: max. 28 Mbps 1920 × 1080/16:9,
FX: max. 24 Mbps 1920 × 1080/16:9,
1280 × 720/16:9
FH: approx. 17 Mbps (ave.) 1920 × 1080/
16:9, 1280 × 720/16:9
HQ: approx. 9 Mbps (ave.) 1440 × 1080/16:9
LP: approx. 5 Mbps (ave.) 1440 × 1080/16:9
 - Standard definition image quality (SD)
HQ: approx. 9 Mbps (ave.) 720 × 576/16:9,
4:3
- Number of pixels and aspect ratio of still images (Still images are created from movies.)
1920 × 1080 dots/16:9

640 × 360 dots/16:9

640 × 480 dots/4:3

Maximum continuous recording time

The maximum continuous recording time for a movie is approximately 13 hours.

Slow and Quick Motion

Estimated recording time and playback stream length for movie content are as follows.

Playback stream length

Approx. h (hour) m (minute)

fps	50p	25p
1	18 m	30 m
2	30 m	1 h 6 m
3	48 m	1 h 36 m
6	1 h 36 m	3 h 18 m
12	3 h 18 m	6 h 30 m
25	6 h 30 m	13 h
50	13 h	13 h

Recording operation time)

Approx. h (hour) m (minute)

fps	50p	25p
1	13 h	13 h
2	13 h	13 h
3	13 h	13 h
6	13 h	13 h
12	13 h	13 h
25	13 h	13 h
50	13 h	6 h 30 m

Using your camcorder abroad

Power supply

You can use your camcorder in any country/region using the AC Adaptor/Charger supplied with your camcorder within the AC 100 V to 240 V, 50 Hz/60 Hz range.

Viewing high definition image quality (HD) movies

In countries/regions where 1080/50i is supported, you can view the movies with the same high definition image quality (HD) as that of the recorded movies. You need a PAL-system-based and 1080/50i compatible TV (or monitor) with component and AUDIO/VIDEO input jacks. The component video cable (supplied) or an HDMI cable (sold separately) must be connected.

Viewing standard definition image quality (SD) movies

To view standard definition image quality (SD) movies, you need a PAL-system-based TV with AUDIO/VIDEO input jacks. An A/V connecting cable must be connected.

On TV color systems

Your camcorder is PAL system, so its picture can only be viewed on a PAL-system TV with AUDIO/VIDEO input jacks.

System	Used in
PAL	Australia, Austria, Belgium, China, Czech Republic, Denmark, Finland, Germany, Holland, Hong Kong, Hungary, Italy, Kuwait, Malaysia, New Zealand, Norway, Poland, Portugal, Singapore, Slovak Republic, Spain, Sweden, Switzerland, Thailand, United Kingdom, etc.
PAL - M	Brazil

System	Used in
PAL - N	Argentina, Paraguay, Uruguay.
SECAM	Bulgaria, France, Guiana, Iran, Iraq, Monaco, Russia, Ukraine, etc.
NTSC	Bahama Islands, Bolivia, Canada, Central America, Chile, Colombia, Ecuador, Guyana, Jamaica, Japan, Korea, Mexico, Peru, Surinam, Taiwan, the Philippines, the U.S.A., Venezuela, etc.

Simple setting of the clock by time difference

When you are abroad, you can easily adjust the clock to the local time by setting the time difference. Select [AREA SET], then set the time difference (p. 80).

File/folder structure on the memory card and the flash memory unit

The file/folder structure is shown below. You do not usually need to acknowledge the file/folder structure, when recording/playing back movies and still images on the camcorder.

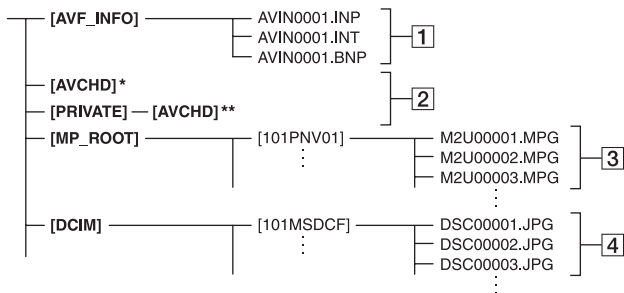

* “Memory Stick PRO Duo” media, flash memory unit

**SD memory card, SDHC memory card, SDXC memory card

1 Image management files

When you delete the files, you cannot record/play back the images correctly. The files are defaulted as hidden files and not usually displayed.

2 HD movie management information folder

This folder contains recording data of high definition image quality (HD) movies. Do not try to open this folder or access the contents of this folder from a computer. Doing so might damage image files, or prevent image files from being played back.

3 SD movie files (MPEG-2 files)

The extension of the files is “.MPG”. The maximum size is 2 GB. When the capacity of a file exceeds 2 GB, the file becomes divided.

The file numbers go up automatically. When the capacity of a file number exceeds 9999, another folder is created to record new movie files. The folder name goes up: [101PNV01] → [102PNV01]

4 Still image files (JPEG files)

The extension of the files is “.JPG”. The file numbers go up automatically. When

the capacity of a file number exceeds 9999, another folder is created to store new still image files.

The folder name goes up: [101MSDCF] → [102MSDCF]

- Do not modify the files or folders on the camcorder from the computer. The image files may be destroyed or may not be played back. Operation is not guaranteed, if you perform this operation.
- When you delete image files, follow the steps on page 61. Do not delete the image files on the camcorder directly from the computer.
- Do not format the recording media in the camcorder using a computer. The camcorder may not operate correctly.
- Do not copy the files on the recording media from a computer. Operation is not guaranteed.
- Use the supplied application software “Content Management Utility” to import data from the recording media to a computer.

Maintenance and precautions

About the AVCHD format

What is the AVCHD format?

The AVCHD format is a high definition digital video camera format used to record an HD (high definition) signal, using efficient data compression coding technology. The MPEG-4 AVC/H.264 format is adopted to compress video data, and the Dolby Digital or Linear PCM system is used to compress audio data. The MPEG-4 AVC/H.264 format is capable of compressing images at higher efficiency than that of the conventional image compressing format.

- Because the AVCHD format uses a data compression system, images may be distorted in scenes where the image, angle, or brightness changes drastically. This is not a malfunction.

Recording and playback on your camcorder

Based on the AVCHD format, your camcorder records with the HD (high definition) image quality. In addition to HD (high definition) image quality, your camcorder is capable of recording a standard definition (SD) signal in the conventional MPEG2 format.

Video signal*: MPEG-4 AVC/H.264

1920 × 1080/50i, 1920 × 1080/25p,

1280 × 720/50p, 1440 × 1080/50i

Audio signal: Dolby Digital 2ch, Linear

PCM 2 ch

Recording media: memory card, flash memory unit (sold separately)

* Data recorded in AVCHD format other than the above mentioned cannot be played back on your camcorder.

- 1080i specification
A high definition specification which utilizes 1,080 effective scanning lines and the interlace system.
- 720p specification
A high definition specification which utilizes 720 effective scanning lines and the progressive system.

About GPS

The GPS (Global Positioning System) is a system that calculates geographical location from highly accurate US space satellites.

This system allows you to pinpoint your exact location on the earth.

The GPS satellites are located in 6 orbits, 20,000 km above the earth. The GPS system consists of 24 or more GPS satellites. A GPS receiver receives radio signals from the satellites, and calculates the current location of the receiver based on the orbital information (almanac data) and travel time of the signals, etc.

Determining a location is called “triangulating.” A GPS receiver can determine the location’s latitude and longitude by receiving signals from 3 or more satellites.

- As the positions of GPS satellites vary constantly, it may take longer to determine the location or the receiver may not be able to determine the location at all, depending on the location and time you use the camcorder.
- “GPS” is a system for determining geographic location by triangulating radio signals from GPS satellites. Avoid using the camcorder in places where radio signals are blocked or reflected, such as a shadowy place surrounded by buildings or trees, etc. Use the camcorder in open sky environments.
- You may not be able to record location information at locations or in situations where radio signals from the GPS satellites do not reach the camcorder as follows.
 - In tunnels, indoors or under the shade of buildings.
 - Between tall buildings or at narrow streets surrounded by buildings.
 - In underground locations, locations surrounded by dense trees, under an elevated bridge, or in locations where magnetic fields are generated, such as near high voltage cables.
 - Near devices that generate radio signals of the same frequency band as the camcorder: near 1.5 GHz band mobile telephones, etc.

On triangulating errors

- If you move to another location right after setting [GPS SETTING] to [ON] in the menu, it may take a longer time for the camcorder to start triangulating, compared to when you stay in the same place.
- Error caused by the position of GPS satellites
The camcorder automatically triangulates your current location when the camcorder receives radio signals from 3 or more GPS satellites. The triangulating error allowed by the GPS satellites is about 10 m (33 feet). Depending on the environment of the location, the triangulating error can be greater. In this case, your actual location may not match the location on the map based on the GPS information. Meanwhile, the GPS satellites are controlled by the United States Department of Defense, and the degree of accuracy may be changed intentionally.
- Error during the triangulating process
The camcorder acquires location information periodically during triangulating.

On the restriction of use of GPS

- Use GPS in accordance with the regulations of the situation, the countries/regions of use.

On the geographic coordinate system

The “WGS-84” geographic coordinate system is used.

About the memory card

- A memory card formatted by a computer (Windows OS/Mac OS) does not have guaranteed compatibility with your camcorder.
 - Data read/write speed may vary depending on the combination of the memory card and memory card compliant product you use.
 - Damaged or lost image data will not be compensated for, and may occur in the following cases:
 - If you eject the memory card, turn the power off on your camcorder, or remove the battery pack for replacement while your camcorder is reading or writing image files on the memory card (while the access lamp is lit or flashing).
 - If you use the memory card near magnets or magnetic fields.
 - It is recommended to make a back-up of important data on the hard disk of a computer.
 - Do not attach a label or the like on memory card or a memory card adaptor.
 - Do not touch, or allow metallic objects to come into contact with the terminals.
 - Do not bend, drop or apply strong force to the memory card.
 - Do not disassemble or modify the memory card.
 - Do not let the memory card get wet.
 - Be careful to keep memory card out of the reach of small children. There is danger that a child might swallow it.
 - Do not insert anything other than the compliant size of memory card into the memory card slot. Doing so may cause a malfunction.
 - Do not use or keep the memory card in the following locations:
 - Places subject to extremely high temperature, such as a car parked outside in the summer.
 - Places under direct sunlight.
 - Places with extremely high humidity or subject to corrosive gases.
- **On the memory card adaptor**
- When inserting memory card into a memory card adaptor, make sure the memory card is inserted facing in the correct direction, then insert it all the way in. Note that improper use may cause a malfunction.

On image data compatibility

- Image data files recorded on a memory card by your camcorder conform to the “Design rule for Camera File system” universal standard established by the JEITA (Japan Electronics and Information Technology Industries Association).
- On your camcorder, you cannot play back still images recorded on other devices (DCR-TRV900E or DSC-D700/D770) that do not conform to the universal standard. (These models are not sold in some regions.)
- If you cannot use the memory card that has been used with another device, format it with your camcorder (p. 63). Note that formatting erases all information on the memory card.
- You may not be able to play back images with your camcorder:
 - When playing back image data modified on your computer.
 - When playing back image data recorded with other devices.

About the “Memory Stick” media

Types of “Memory Stick” media	Recording /Playback
“Memory Stick Duo” media (with MagicGate)	–
“Memory Stick PRO Duo” media (Mark2)	○
“Memory Stick PRO-HG Duo” media	*

- This product supports parallel data transfer. However, the transfer speed may differ, depending on the type of media you use.
- This product cannot record or play data that uses “MagicGate” technology. “MagicGate” is a copyright protection technology that records and transfers the contents in an encrypted format.

About the “InfoLITHIUM” battery pack

Your camcorder operates only with an “InfoLITHIUM” L series battery pack of a large capacity, such as NP-F770 (supplied) and NP-F970 (sold separately). You cannot use NP-F570.

“InfoLITHIUM” L series battery packs have the  mark.

What is an “InfoLITHIUM” battery pack?

An “InfoLITHIUM” battery pack is a lithium-ion battery pack that has functions for communicating information related to operating conditions between your camcorder and a supplied AC Adaptor/Charger.

The “InfoLITHIUM” battery pack displays the remaining battery time in % according to the operating situations of your camcorder.

To charge the battery pack

- Be sure to charge the battery pack before you start using your camcorder.
- We recommend charging the battery pack in an ambient temperature of from 10 °C to 30 °C (50 °F to 86 °F) until the charge lamp of the AC Adaptor/Charger turns off. If you charge the battery pack outside of this temperature range, you may not be able to charge it efficiently.

To use the battery pack effectively

- Battery pack performance decreases when the ambient temperature is 10 °C (50 °F) or below, and the length of time you can use the battery pack becomes shorter. In that case, do one of the following to use the battery pack for a longer time.
 - Put the battery pack in a pocket to warm it up, and install it in your camcorder right before you start taking shots.
 - Use a large capacity battery pack: NP-F970 (sold separately).
- Be sure to set the POWER switch to OFF when not recording or playing back on your camcorder. The battery pack is also consumed

Maintenance and precautions (Continued)

when your camcorder is in recording standby or playback pause.

- Have spare battery packs ready for 2 or 3 times the expected recording time, and make trial recordings before making the actual recording.
- Do not expose the battery pack to water. The battery pack is not water resistant.

About the remaining battery indicator

- Check the level with the following indicators and % displayed on the LCD screen.

Battery remaining indicator	%
	61% to 100%
	41% to 60%
	21% to 40%
	1% to 20%
	-

- The displayed level may not be correct under certain circumstances.
- When the power goes off even though the remaining battery time indicator indicates that the battery pack has enough power to operate, charge the battery pack fully again. Remaining battery time will be indicated correctly. Note, however, that the battery indication will not be restored if it is used in high temperatures for a long time, or if left in a fully charged state, or when the battery pack is frequently used. Use the remaining battery time indication as a rough guide only.

About storage of the battery pack

- If the battery pack is not used for a long time, fully charge the battery pack and use it up on your camcorder once a year to maintain proper function. To store the battery pack, remove it from your camcorder and put it in a dry, cool place.
- To discharge the battery pack on your camcorder completely, leave your camcorder in recording standby until the power goes off.

About battery life

- Battery capacity decreases over time and through repeated use. If decreased usage time between charges becomes significant, it is probably time to replace it with a new one.
- Each battery's life is governed by storage, operating and environmental conditions.

About charging the battery pack

- Use the AC Adaptor/Charger (supplied) to charge the designated batteries only. If you charge other types of batteries, those batteries may leak, heat up, burst, or give an electric shock, resulting in burns or injury.
- Remove the charged battery from the AC Adaptor/Charger.
- The CHARGE lamp of the supplied AC Adaptor/Charger flashes in 2 patterns as follows:
 - Fast-flashing...Turns on and off rapidly at about 0.15-second intervals.
 - Slow-flashing...Turns on and off alternately for about 1.5 seconds, and turns off completely for about 1.5 seconds. The lamp repeats this sequence.
- If the CHARGE lamp is fast-flashing, remove the battery that is being charged, and then re-attach the same battery again firmly. If the CHARGE lamp continues fast-flashing, the cause could be that the battery is damaged, or the battery is not a designated type. Check the battery to confirm whether it is a designated type or not. If it is a designated type, remove the battery first, and then attach a brand-new battery or another known-to-be-good battery to see if the AC Adaptor/Charger is working correctly. If the AC Adaptor/Charger is working correctly, the cause could be that the battery is damaged.
- If the CHARGE lamp is slow-flashing, the AC Adaptor/Charger is in standby mode and charging is suspended. When the ambient temperature is out of the appropriate temperature range for charging, the AC Adaptor/Charger suspends charging automatically and enters standby mode. When the ambient temperature returns to an appropriate temperature, the AC Adaptor/Charger restarts charging and the CHARGE lamp lights up. We recommend charging the battery pack in an ambient temperature of from 10 °C to 30 °C (50 °F to 86 °F).

About handling of your camcorder

On use and care

- Do not use or store the camcorder and accessories in the following locations.
 - Anywhere extremely hot or cold. Never leave them exposed to temperatures above 60 °C (140 °F), such as under direct sunlight, near heaters or in a car parked in the sun. They may malfunction or become deformed.
 - Near strong magnetic fields or mechanical vibration. The camcorder may malfunction.
 - Near strong radio waves or radiation. The camcorder may not be able to record properly.
 - Near AM receivers and video equipment. Noise may occur.
 - On a sandy beach or anywhere dusty. If sand or dust gets in your camcorder, the camcorder may malfunction. Sometimes this malfunction cannot be repaired.
 - Near windows or outdoors, where the LCD screen, the viewfinder, or the lens may be exposed to direct sunlight. This damages the inside of the viewfinder or the LCD screen.
 - Anywhere very humid.
- Operate your camcorder on DC 7.2 V (battery pack) or DC 8.4 V (AC Adaptor).
- For DC or AC operation, use the accessories recommended in these operating instructions.
- Do not let your camcorder get wet, for example, from rain or sea water. If your camcorder gets wet, it may malfunction. Sometimes this malfunction cannot be repaired.
- If any solid object or liquid gets inside the casing, unplug your camcorder and have it checked by a Sony dealer before operating it any further.
- Avoid rough handling, disassembling, modifying, physical shock, or impact such as hammering, dropping or stepping on the product. Be particularly careful of the lens.
- Do not use a deformed or damaged battery pack.
- Keep the POWER switch set to OFF when you are not using your camcorder.
- Do not wrap your camcorder with a towel, for example, and operate it. Doing so might cause heat to build up inside.
- When disconnecting the power cord (mains lead), pull it by the plug and not the lead.

- Do not damage the power cord (mains lead) such as by placing anything heavy on it.
- Keep metal contacts clean.
- Keep the Wireless Remote Commander and button-type battery out of children's reach. If the battery is accidentally swallowed, consult a doctor immediately.
- If the battery electrolytic liquid has leaked,
 - consult your local authorized Sony service facility.
 - wash off any liquid that may have contacted your skin.
 - if any liquid gets in your eyes, wash with plenty of water and consult a doctor.

■ When not using your camcorder for a long time

- Turn on the camcorder and record and play back images about once a month to keep it in an optimum state for a long time.
- Use up the battery pack completely before storing it.

Moisture condensation

If your camcorder is brought directly from a cold place to a warm place, moisture may condense inside your camcorder and cause a malfunction of your camcorder.

■ If moisture condensation has occurred

Leave your camcorder for about 1 hour without turning it on.

■ Note on moisture condensation

Moisture may condense when you bring your camcorder from a cold place into a warm place (or vice versa) or when you use your camcorder in a humid place as shown below.

- When you bring your camcorder from a ski slope into a place warmed up by a heating device.
- When you bring your camcorder from an air conditioned car or room into a hot place outside.
- When you use your camcorder after a squall or a shower.
- When you use your camcorder in a hot and humid place.

■ How to avoid moisture condensation

When you bring your camcorder from a cold place into a warm place, put your camcorder in a plastic bag and seal it tightly. Remove the bag when the

Maintenance and precautions (Continued)

air temperature inside the plastic bag has reached the ambient temperature (after about 1 hour).

LCD screen

- Do not exert excessive pressure on the LCD screen, as it may cause damage.
- If your camcorder is used in a cold place, a residual image may appear on the LCD screen. This is not a malfunction.
- While using your camcorder, the back of the LCD screen may heat up. This is not a malfunction.

■ To clean the LCD screen

The LCD screen is covered with a coating. The coating may be peeled off by scratching or rubbing. Maintain the LCD screen as follows.

- Wipe dirt off the LCD screen with a clean, soft cloth, such as an eye glass cleaning cloth, etc.
- Before wiping the LCD screen, blow dust or sand off with a dust blower, etc.
- If you rub the LCD screen hard, even with a tissue, the coating may be damaged.
- Wipe fingerprints or hand cream off the LCD screen as soon as possible, as they may cause the coating to peel off.

■ To adjust the touch panel (CALIBRATION)

The buttons on the touch panel may not work correctly. If this happens, follow the procedure below. It is recommended that you connect your camcorder to the wall outlet (wall socket) using the supplied AC Adaptor/Charger during the operation.

- ① Press the MENU button → select  (OTHERS) → [CALIBRATION] with the SEL/PUSH EXEC dial.



- ② Touch "x" displayed on the screen with the corner of memory card or the like 3 times.

⚠ Notes

- If you did not press the right spot, try the calibration again.
- Do not use a sharp-pointed object for calibration. Doing so may damage the LCD screen.
- You cannot perform the calibration when the LCD screen is turned around, or facing up and closed to the camcorder

Casing

- If the casing is soiled, clean the camcorder body with a soft cloth lightly moistened with water, and then wipe the casing with a dry soft cloth.
- Avoid the following to prevent damage to the finish.
 - Using chemicals such as thinner, benzene, alcohol, chemical cloths, repellent, insecticide and sunscreen.
 - Handling with above substances on your hands.
 - Leaving the casing in contact with rubber or vinyl objects for a long period of time.

Care and storage of the lens

- Wipe the surface of the lens clean with a soft cloth in the following instances:
 - When there are fingerprints on the lens surface.
 - In hot or humid locations
 - When the lens is exposed to salty air such as at the seaside.
- Store in a well-ventilated location subject to little dirt or dust.
- To prevent mold, periodically clean the lens as described above.

Charging the pre-installed rechargeable battery

Your camcorder has a pre-installed rechargeable battery to retain the date, time, and other settings even when the POWER switch is set to OFF. The pre-installed rechargeable battery is always charged while your camcorder is connected to the wall outlet (wall socket) via the AC Adaptor/Charger or while the battery pack is attached. The rechargeable battery will be fully discharged in about **3 months** if you do not use your camcorder at all without the AC Adaptor/Charger connected or the battery pack attached. Use your

camcorder after charging the pre-installed rechargeable battery.

However, even if the pre-installed rechargeable battery is not charged, the camcorder operation will not be affected as long as you are not recording the date.

■ Procedures

Connect your camcorder to a wall outlet (wall socket) using the supplied AC Adaptor/Charger, and leave it with the POWER switch set to OFF for more than 24 hours.

Removing dust from inside the viewfinder

Remove dust inside the eye piece and viewfinder with a blower.

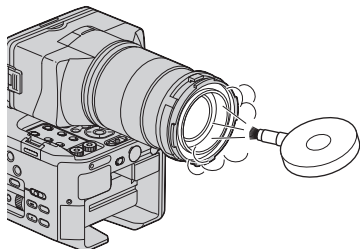

Note on disposal of the camcorder

When you dispose of the camcorder, it is recommended that you destroy the actual body of the camcorder.

Note on disposal/transfer of memory card

Even if you delete data in the memory card or format the memory card on your camcorder or a computer, you may not delete data from the memory card completely. When you give the memory card to somebody, it is recommended that you delete data completely using data deletion software on a computer. Also, when you dispose of the memory card, it is recommended that you destroy the actual body of the memory card.

Specifications

System

Video signal

PAL color, CCIR standards
HDTV 1080/50i, 1080/50p, 720/50p
specification

Video recording system

HD image quality: MPEG-4 AVC/
H.264 AVCHD format compatible
(1080/50p: original format)
SD image quality: MPEG-2 PS

Audio recording system

Linear PCM 2ch (48 kHz 16-bit)
Dolby Digital 2ch (48 kHz 16-bit)
Dolby Digital Stereo Creator employed

Still image recording system

DCF Ver. 2.0 Compatible
Exif Ver. 2.3 Compatible
MPF Baseline Compatible

Recording media (movies/still images)

“Memory Stick PRO Duo” media
Flash memory units
SD card (Class 4 or faster)

Image device

“Exmor” Super35 CMOS sensor
23.6 mm × 13.3 mm (Ø 27.1 mm)
Gross: Approx. 3 530 000 pixels
Effective (movie, 16:9):
Approx. 3 370 000 pixels
Effective (movie, 4:3):
Approx. 2 530 000 pixels

Color temperature

[AUTO]
 (one push) A/B
[INDOOR] (3 200K)
[OUTDOOR] (5 800K)

Minimum illumination

1.5 lx (lux) with Shutter Speed 1/25,
auto gain control, auto iris (using the E
18-200 mm F3.5-6.3 OSS lens*)

* Supplied with NEX-FS100EK/FS100PK

Input/output connectors

VIDEO OUT jack

Pin connector
Video output
1 Vp-p, 75 Ω (ohms) unbalanced, sync
negative

AUDIO OUT jacks

Pin connectors
-10 dBu (at load impedance 47 kΩ
(kilohms)), Output impedance with less
than 2.2 kΩ (kilohms)
(0 dBu = 0.775 Vrms)

COMPONENT OUT jack

Mini-D jack
Y: 1 Vp-p, 75 Ω (ohms)
PB/PR, CB/CR: 0.7 Vp-p, 75 Ω (ohms)

REMOTE jack

Stereo mini-minijack (Ø 2.5 mm)

HDMI OUT jack

HDMI Connector (Type A)

USB jack

mini-AB

📶 (headphones) jack

Stereo minijack (Ø 3.5 mm)

INPUT1/INPUT2 jacks

XLR 3-pin, female,
MIC: -48 dBu/3 kΩ (kilohms)
LINE: +4 dBu/10 kΩ (kilohms)
(0 dBu = 0.775 Vrms)

LCD screen

Picture

8.8 cm (3.5 type, aspect ratio 16:9)

Total dot number

921 600 (1 920 × 480)

General

Power requirements

- DC 7.2 V (battery pack)
- DC 8.4 V (AC Adaptor/Charger)

Average power consumption

During camera recording using the microphone ECM-XM1, LCD with normal brightness (using the E 18-200 mm F3.5-6.3 OSS lens*)

5.6 W

When Flash Memory Unit HXR-FMU128 is used, the average power consumption increases about 1.1 W.

Operating temperature

0 °C to 40 °C (32 °F to 104 °F)

Storage temperature

-20 °C to +60 °C (-4 °F to +140 °F)

Dimensions (approx.)

Camcorder body only (including the projecting parts):

126.5 mm × 101.5 mm × 193.5 mm
(5 in. × 4 in. × 7 5/8 in.) (w/h/d)

When recording (including the projecting parts):

178 mm × 192 mm × 519.5 mm
(7 1/8 in. × 7 5/8 in. × 20 1/2 in.) (w/h/d)
(With the accessories (lens*, lens hood*, large LCD viewfinder, large eyecup, handle, microphone (ECM-XM1), and grip (without the belt) attached.)

Mass (approx.)

Camcorder body only:

1 040 g (2 lb 4 oz)

When recording:

2 660 g (5 lb 13 oz) (With the accessories (battery pack (NP-F770), lens*, lens hood*, large LCD viewfinder, large eyecup, handle, microphone (ECM-XM1), grip, and flash memory unit cover attached.)

* Supplied with NEX-FS100EK/FS100PK

AC Adaptor/Charger AC-VL1

Power requirements

AC 100 V - 240 V, 50 Hz/60 Hz

Power consumption

22 W

Output voltage

DC 8.4 V*

Operating temperature

0 °C to 40 °C (32 °F to 104 °F)

Storage temperature

-20 °C to +60 °C (-4 °F to +140 °F)

Dimensions (approx.)

136 mm × 51 mm × 90 mm
(5 3/8 in. × 2 1/8 in. × 3 5/8 in.) (w/h/d)
excluding the projecting parts

Mass (approx.)

270 g (9.6 oz) excluding the power cord
(mains lead)

* See the label on the AC Adaptor/Charger for other specifications.

Rechargeable battery pack NP-F770

Maximum output voltage

DC 8.4 V

Output voltage

DC 7.2 V

Maximum charge voltage

DC 8.4 V

Maximum charge current

3.0 A

Capacity

Typical: 31.7 Wh (4 400 mAh)

Minimum: 30.0 Wh (4 200 mAh)

Type

Li-ion

Specifications (Continued)

E 18-200 mm F3.5-6.3 OSS lens (Supplied with NEX-FS100EK/ FS100PK)

Lens

E-mount lens

When converted to a 35 mm still camera

28.8 mm - 320 mm (1 3/16 in. -

12 5/8 in.) (16:9)

36 mm - 400 mm (1 7/16 in. -

15 3/4 in.) (4:3)

F-value

F3.5-F6.3

SteadyShot

Optical-shift biaxial-linear-drive and
hall effect sensor

Minimum focus*

0.30 m (W) - 0.50 m (T) (11 7/8 in. -

19 3/4 in.)

Maximum magnification

×0.35

Minimum f-stop

f/22 - f/40

Filter diameter

67 mm (2 3/4 in.)

Dimensions (approx. max. diameter × height)

75.5 mm × 99.0 mm (3 in. × 4 in.)

Mass (approx.)

524 g (18 1/2 oz.)

* Minimum focus is the shortest distance from the
image sensor to the subject.

Design and specifications are subject to change
without notice.

- Manufactured under license from Dolby
Laboratories.

On trademarks

- “NXCAM” logo is a trademark of Sony Corporation.
- “AVCHD” and “AVCHD” logotype are trademarks of Panasonic Corporation and Sony Corporation.
- “Memory Stick,” “,” “Memory Stick Duo,” “MEMORY STICK DUO,” “Memory Stick PRO Duo,” “MEMORY STICK PRO DUO,” “Memory Stick PRO-HG Duo,” “MEMORY STICK PRO-HG DUO,” “MagicGate,” “MAGIC GATE,” “MagicGate Memory Stick” and “MagicGate Memory Stick Duo” are trademarks of Sony Corporation.
- “InfoLITHIUM” is a trademark of Sony Corporation.
- “BRAVIA” is a trademark of Sony Corporation.
- Blu-ray Disc™ and Blu-ray™ are trademarks of the Blu-ray Disc Association.
- Dolby and the double-D symbol are trademarks of Dolby Laboratories.
- Microsoft, Windows, and Windows Vista are trademarks or registered trademarks of U.S. Microsoft Corporation in the U.S. and other countries.
- Macintosh and Mac OS are registered trademarks of Apple Inc. in the U.S. and other countries.
- HDMI, HDMI logo, and High-Definition Multimedia Interface are registered trademarks of HDMI Licensing LLC in the United States and other countries.
- Intel, Intel Core, and Pentium are trademarks or registered trademarks of Intel Corporation or its subsidiaries in the United States and other countries.
- Adobe, the Adobe logo, and Adobe Acrobat are either registered trademarks or trademarks of Adobe Systems Incorporated in the United States and/or other countries.
- SDXC logo is a trademark of SD-3C, LLC.
- MultiMedia Card is a trademark of MultiMediaCard Association.

All other product names mentioned herein may be the trademarks or registered trademarks of their respective companies. Furthermore, ™ and “®” are not mentioned in each case in this manual.

Notes on the License

ANY USE OF THIS PRODUCT OTHER THAN CONSUMER PERSONAL USE IN ANY MANNER THAT COMPLIES WITH THE MPEG-2 STANDARD FOR ENCODING VIDEO INFORMATION FOR PACKAGED MEDIA IS EXPRESSLY PROHIBITED WITHOUT A LICENSE UNDER APPLICABLE PATENTS IN THE MPEG-2 PATENT PORTFOLIO, WHICH LICENSE IS AVAILABLE FROM MPEG LA, L.L.C., 250 STEELE STREET, SUITE 300, DENVER, COLORADO 80206.

THIS PRODUCT IS LICENSED UNDER THE AVC PATENT PORTFOLIO LICENSE FOR THE PERSONAL AND NON-COMMERCIAL USE OF A CONSUMER TO

(i) ENCODE VIDEO IN COMPLIANCE WITH THE AVC STANDARD (“AVC VIDEO”) AND /OR

(ii) DECODE AVC VIDEO THAT WAS ENCODED BY A CONSUMER ENGAGED IN A PERSONAL AND NON-COMMERCIAL ACTIVITY AND/OR WAS OBTAINED FROM A VIDEO PROVIDER LICENSED TO PROVIDE AVC VIDEO.

NO LICENSE IS GRANTED OR SHALL BE IMPLIED FOR ANY OTHER USE.

ADDITIONAL INFORMATION MAY BE OBTAINED FROM MPEG LA, L.L.C.

SEE <[HTTP://WWW.MPEGLA.COM](http://www.mpegla.com)>

“C Library,” “zlib,” and “libjpeg” software are provided in your camcorder. We provide this software based on license agreements with their owners of copyright. Based on requests by the owners of copyright of these software applications, we have an obligation to inform you of the following. Please read the following sections.

Read “license3.pdf” in the “License” folder on the CD-ROM “Content Management Utility.” You will find licenses (in English) of “C Library,” “zlib,” and “libjpeg” software.

On GNU GPL/LGPL applied software

The software that is eligible for the following GNU General Public License (hereinafter referred to as “GPL”) or GNU Lesser General Public License (hereinafter referred to as “LGPL”) are included in the camcorder.

This informs you that you have a right to have access to, modify, and redistribute source code for these software programs under the conditions of the supplied GPL/LGPL.

Source code is provided on the web. Use the following URL to download it. When downloading the source code, select NEX-FS100J as the model for your camcorder.

<http://www.sony.net/Products/Linux/>

We would prefer you do not contact us about the contents of source code.

Read “license2.pdf” in the “License” folder on the CD-ROM “Content Management Utility.” You will find licenses (in English) of “GPL,” and “LGPL” software.

To view the PDF, Adobe Reader is needed. If it is not installed on your computer, you can download it from the Adobe Systems web page:

<http://www.adobe.com/>

Identifying parts and controls

The numbers in () are reference pages.

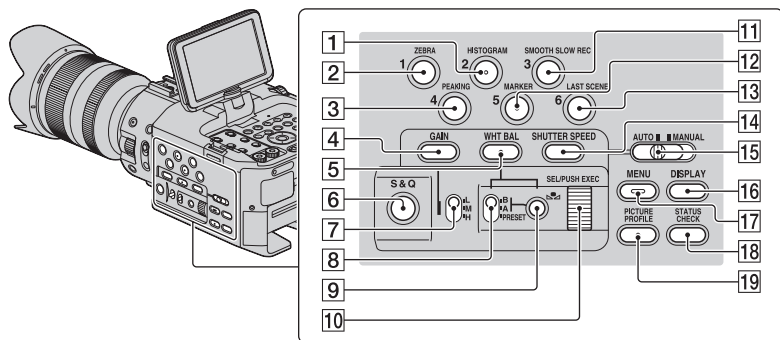

1 HISTOGRAM/ASSIGN 2 button* (48)

2 ZEBRA/ASSIGN 1 button (48)

3 PEAKING/ASSIGN 4 button (48)

4 GAIN button (31)

5 WHT BAL button* (33)

6 S&Q button (46)

7 Gain switch (31)

8 White balance memory switch (33)

9 (One push) button (34)

10 SEL/PUSH EXEC dial (21, 66)

11 SMOOTH SLOW REC/ASSIGN 3 button (45, 48)

12 MARKER/ASSIGN 5 button* (48)

13 LAST SCENE/ASSIGN 6 button (48, 48)

14 SHUTTER SPEED button (32)

15 AUTO/MANUAL switch (31)

16 DISPLAY button (54)

17 MENU button** (21, 66)

18 STATUS CHECK button (55)

19 PICTURE PROFILE button* (38)

tactile dots for your convenience in locating the buttons.

**MENU button has a raised tactile bar for your convenience in locating the buttons.

* HISTOGRAM/ASSIGN 2 button, MARKER/ASSIGN 5 button, PICTURE PROFILE button, and WHT BAL button have raised

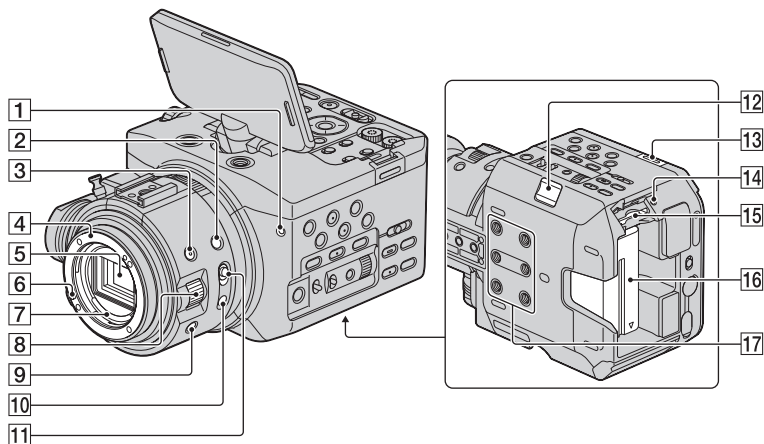

1 Front recording lamp (82)
The recording lamp flashes if the remaining capacity of recording media or battery is low.

2 EXPANDED FOCUS button (30)

3 IRIS button (31)

4 Lens mount (18)

5 Image sensor

6 Lens lock pin

7 Lens contacts

Do not touch or dirty the lens contacts.

8 Iris ring (31)

9 IRIS PUSH AUTO button (31)

10 PUSH AUTO button (30)

11 FOCUS switch (29)

12 BATT RELEASE button (16)

13 Hook for shoulder strap

14 Access lamp (24)

15 Memory card slot (23)

16 Battery pack (15)

17 Tripod receptacles

For attaching a tripod with a screw shorter than 5.5 mm (sold separately).

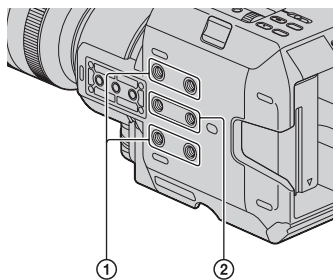

1 For 1/4-20UNC screws

2 For 3/8-16UNC screws

Identifying parts and controls (Continued)

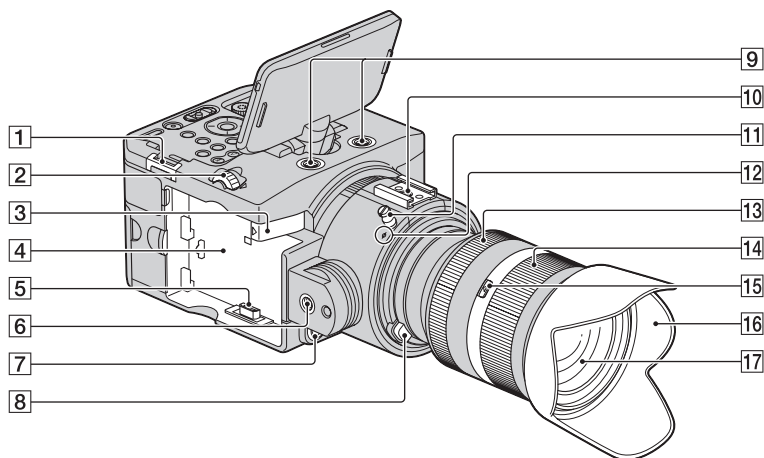

- 1 Hook for shoulder strap
- 2 LCD HOLD dial (14)
- 3 Flash memory unit RELEASE lever (24)
- 4 Flash memory unit mount (24)
- 5 Flash memory unit jack
- 6 Grip respectable (12)
- 7 START/STOP button (26)
- 8 Lens release button (18)
- 9 Expansion receptacles
For 1/4-20UNC screws
- 10 Accessory shoe (15)
- 11 Tape measure hook (14)
- 12 Image sensor position index
- 13 Focusing ring (29) (NEX-FS100EK/
FS100PK)
- 14 Zooming ring (29) (NEX-FS100EK/
FS100PK)
- 15 Zoom lock switch (NEX-FS100EK/
FS100PK)
- 16 Lens hood (18) (NEX-FS100EK/
FS100PK)



- 17 Lens (18) (NEX-FS100EK/FS100PK)

To attach a shoulder strap

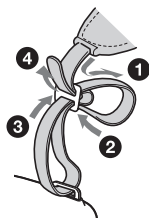
Attach a shoulder strap (sold separately) to the hooks for a shoulder strap.

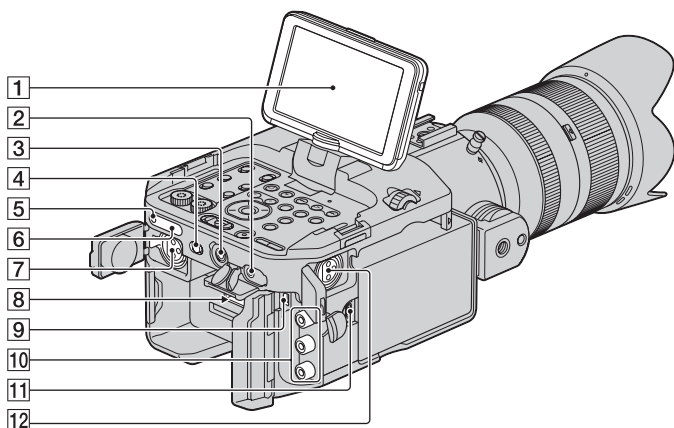



- 1** LCD screen/touch panel (14)
- 2** REMOTE jack
The REMOTE jack is used for controlling playback, etc. on the video device and peripherals connected to it.
- 3**  (headphones) jack
For connecting stereo mini-jack headphones.
- 4** HEADPHONE MONITOR switch (37)
- 5** Rear recording lamp (82)
The recording lamp flashes if the remaining capacity of recording media or battery is low.
- 6** Remote sensor (82)
- 7** INPUT 2 jack (11)
- 8** HDMI OUT jack (56)
- 9** COMPONENT OUT jack (56)
- 10** VIDEO OUT/AUDIO OUT jacks (56)
- 11**  (USB) jack (85, 87)
- 12** INPUT 1 jack (11)

Identifying parts and controls (Continued)

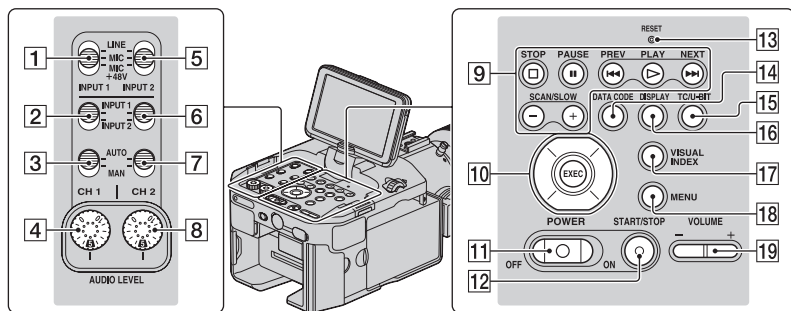

- 1** INPUT 1 switch (35)
- 2** CH1 (INPUT 1/INPUT 2) switch (35)
- 3** CH1 (AUTO/MAN) switch (35)
- 4** AUDIO LEVEL (CH1) dial (35)
- 5** INPUT 2 switch (35)
- 6** CH2 (INPUT 1/INPUT 2) switch (35)
- 7** CH2 (AUTO/MAN) switch (35)
- 8** AUDIO LEVEL (CH2) dial (35)
- 9** Playback control buttons (PREV/
PLAY*/NEXT/STOP/PAUSE/SCAN/
SLOW) (50)
- 10** ▲/▼/◀/▶/EXEC buttons (66)
- 11** POWER switch (21)
- 12** START/STOP button (26)
- 13** RESET button
If you press the RESET button, all settings
including the clock setting (except the picture
profile settings) return to the default.
- 14** DATA CODE button (54)
- 15** TC/U-BIT button
Switches between time code and user bit to
display on the LCD screen.
- 16** DISPLAY button (54)
- 17** VISUAL INDEX button (50)
- 18** MENU button (21, 66)
- 19** VOLUME buttons* (50)

* VOLUME+ button, and PLAY button have raised tactile dots for your convenience in locating the buttons.

Wireless Remote Commander

Remove the insulation sheet before using the Wireless Remote Commander.

Insulation sheet

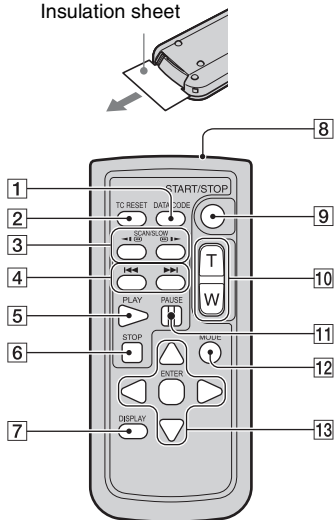

- 1 DATA CODE button (54)
- 2 TC RESET button (44)
- 3 SCAN/SLOW buttons (50)
- 4 ◀▶ (PREV/NEXT) buttons (50)
- 5 PLAY button (50)
- 6 STOP button (50)
- 7 DISPLAY button (54)
- 8 Transmitter
- 9 START/STOP button (26)
- 10 Power zoom buttons
You cannot use this button with this camcorder.
- 11 PAUSE button (50)
- 12 MODE button
- 13 ◀▶/▲/▼/ENTER buttons

Notes

- Aim the Wireless Remote Commander towards the remote sensor to operate your camcorder.
- Point the remote sensor away from strong light sources such as direct sunlight or overhead lighting. Otherwise, the Wireless Remote Commander may not function properly.
- When you are operating with the Wireless Remote Commander supplied with your camcorder, your video device may also operate. In that case, select a commander mode other than DVD2 for your video device, or cover the sensor of your video device with black paper.

To change the battery of the Wireless Remote Commander

- 1 While pressing on the tab, inset your fingernail into the slit to pull out the battery case.
- 2 Place a new battery with the + side facing up.
- 3 Insert the battery case back into the Wireless Remote Commander until it clicks.

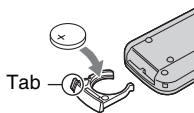

WARNING

Battery may explode if mistreated. Do not recharge, disassemble or dispose of in fire.

- When the lithium battery becomes weak, the operating distance of the Wireless Remote Commander may shorten, or the Wireless Remote Commander may not function properly. In this case, replace the battery with a Sony CR2025 lithium battery. Use of another battery may present a risk of fire or explosion.

Screen indicators

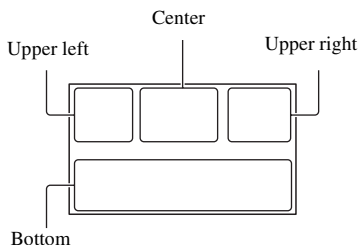

Upper left

Indicator	Meaning
100%	Remaining battery

Center

Indicator	Meaning
	Recording media
STBY REC	Recording status (26)
	Warning (97)
	Playback indicator (50)

Upper right

Indicator	Meaning
Omin	Estimated remaining recording time
	Recording/playback media
00:00:00:00	Time code (hour:minute:second:frame)

Bottom

Indicator	Meaning
	GPS triangulating status (43)
PEAKING	PEAKING (76)
	ZEBRA (76)
	STEADYSHOT (72)
	Manual focus (29)
PP1 ~ PP6	Picture profile (38)
F3.5	Iris (31)
9dB	Gain (31)
50	Shutter speed (32)
	Manual volume control (37)
LPCM	
-2.0EV	AE SHIFT (71)
	Auto setting (77)
	White balance (33)
	Histogram (76)

Tips

- Indicators may look different or appear at different positions.
- Some indicators may not appear, depending on your camcorder model.

Data code during recording

The recording date, time and condition are recorded automatically on the recording media. They are not displayed while recording. However, you can check them by pressing the DATA CODE button (p. 54).

Index

- A**
- AC Adaptor/Charger.....15
 - Access lamp.....24
 - Accessory shoe.....15
 - AE SHIFT.....71, 92
 - AGC LIMIT.....71
 - AREA SET.....80
 - ASPECT.....77
 - ASSIGN BUTTON.....49
 - ASSIGN buttons.....48
 - AUDIO LEVEL DISPLAY.....78
 - AUDIO LIMIT.....74
 - AUDIO SET menu.....74
 - AUTO AREA ADJ.....81
 - AUTO CLOCK ADJ.....81
 - AUTO/MAN (CH1/CH2) switch.....35
- B**
- BATT RELEASE (battery release) button.....16
 - Battery.....15
 - BEEP.....81
 - BLACK BALANCE.....34
 - BLACK GAMMA.....40
 - BLACK LEVEL.....40
 - Button-type lithium battery.....119
- C**
- CALIBRATION.....108
 - CAMERA DATA DISPLAY.....77
 - CAMERA SET menu.....71
 - CENTER.....77
 - Charge lamp.....15
 - Charging time.....16
 - CLOCK SET.....21
 - COLOR BAR.....72, 92
 - COLOR DEPTH.....41
 - COLOR LEVEL.....41
 - COLOR MODE.....41
 - COLOR PHASE.....41
 - Connect
 - Computer.....87
 - DVD writer.....85
 - External media device...83
 - Recorder.....86
 - TV.....56
 - Connecting cord.....17
 - COPY.....62
- D**
- DATA CODE button.....54
 - Date and time.....22, 120
 - DATE REC.....81
 - DELETE.....61
 - DETAIL.....42
 - DISPLAY button.....54
 - DISPLAY OUTPUT.....78
 - DISPLAY SET menu.....76
 - DIVIDE.....60
 - DOWN CONVERT TYPE.....73
- E**
- EXPANDED FOCUS.....30
- F**
- Flash memory unit.....24
 - Flash memory unit jack.....24
 - Focus.....29
 - FOCUS switch.....30
 - Focusing ring.....30
 - FREE RUN.....79
- G**
- Gain.....31
 - GAIN button.....31
 - GAIN SET.....71
 - Gain switch.....31
- H**
- GAMMA.....40
 - GPS.....43
 - GPS INFORMATION.....80
 - GPS SETTING.....43
 - GUIDEFRAAME.....77
- H**
- HD AUDIO FORMAT.....74
 - HD REC FORMAT.....28
 - HDMI/COMPONENT.....73
 - HD/SD SET.....28
 - HEADPHONE OUT.....74
 - Headphones jack.....117
 - HISTOGRAM.....76
- I**
- Image database file.....65
 - INDOOR.....33
 - “InfoLITHIUM” battery pack.....105
 - INPUT 1 jack.....35
 - INPUT 1 switch.....35
 - INPUT 2 jack.....35
 - INPUT 2 switch.....35
 - INPUT1 TRIM.....75
 - INPUT1 WIND.....75
 - INPUT2 TRIM.....75
 - INPUT2 WIND.....75
 - Insulation sheet.....119
 - IRIS.....31
 - IRIS button.....31
 - IRIS PUSH AUTO button...31
 - Iris ring.....31
 - Items.....68
- K**
- KNEE.....40
- L**
- LANGUAGE.....80
 - Large eyecup.....13

Index (Continued)

- LAST SCENE button 48
Last Scene Review 48
LCD BRIGHT 78
Lens 18, 108
- M**
- MANU WB TEMP..... 33
MARKER 77, 92
MEDIA FORMAT 63
Memory card 23, 104
 Insert/Eject 23
Memory card slot..... 24
“Memory Stick” media
 105
“Memory Stick PRO Duo”
media 105
Menu..... 68
 AUDIO SET menu 74
 CAMERA SET menu... 71
 DISPLAY SET menu... 76
 Items 68
 OTHERS menu 80
 REC/OUT SET menu... 73
 TC/UB SET menu 79
 Using 66
MENU button 21, 66
MIC+48V 36
Moisture condensation 107
- N**
- NTSC..... 101
- O**
- One push button..... 34
OPERATION TIME..... 82
OTHERS menu..... 80
OUTDOOR 33
Outside power source 17
- P**
- PAL 101
- PEAKING 76, 92
PHOTO CAPTURE..... 59
Picture profile 38
PICTURE PROFILE button
 38
Playback 50
Power cord (mains lead) 17
POWER switch 21
Pre-installed rechargeable
battery 108
PROTECT 58
PUSH AUTO button..... 30
Push auto focus 30
- R**
- REC LAMP[F]..... 82
REC LAMP[R] 82
REC RUN 79
REC SET..... 73
Recording 26
Recording format 28
Recording image quality 28
Recording lamp..... 26
REC/OUT SET menu 73
REMOTE CONTROL 82
Remote sensor..... 117
REPAIR IMAGE DB FILE
 65
RESET button 118
- S**
- SAFETY ZONE..... 77
Screen indicators 120
SD WIDE REC 73
Self-diagnosis display 97
SEL/PUSH EXEC dial.. 21, 66
Shoulder strap 116
Shutter speed 32
SHUTTER SPEED button
 32
Simultaneous recording 27
Slow & Quick Motion..... 46
- SMOOTH SLOW REC..... 45
Specifications 110
Status check..... 55
STATUS CHECK button 55
STEADYSHOT 72
Still image 59
SUMMERTIME..... 80
S&Q button 46
- T**
- TC MAKE 79
TC PRESET 44, 92
TC RUN 79
TC/UB SET menu 79
TC/U-BIT button 118
TONE 72
Trademark 112
Transmitter 119
Triangulating information ... 43
Troubleshooting 89
TV 56
TV color systems 101
- U**
- UB PRESET 44
UB TIME REC..... 79
USB CONNECT 82
Using your camcorder abroad
 101
- V**
- VIDEO OUT 73
Viewfinder lens adjustment
ring 13
VISUAL INDEX button..... 50
Volume 52
VOLUME buttons 52
- W**
- Warning indicators 97
Warning messages..... 98

WB OUTDOOR LEVEL.....	71
WB PRESET	71
WB SHIFT.....	42
WB TEMP SET	71
White balance	33
White balance memory switch	34
WHT BAL button	33
Wireless Remote Commander	119

X

XLR AGC LINK	75
XLR SET	75

Z

ZEBRA	76, 92
ZOOM DISPLAY.....	78
Zooming.....	29

<http://www.sony.net/>

Printed in Japan



4279232120